

M6[®]^C
artificial cervical disc

Operative Technique

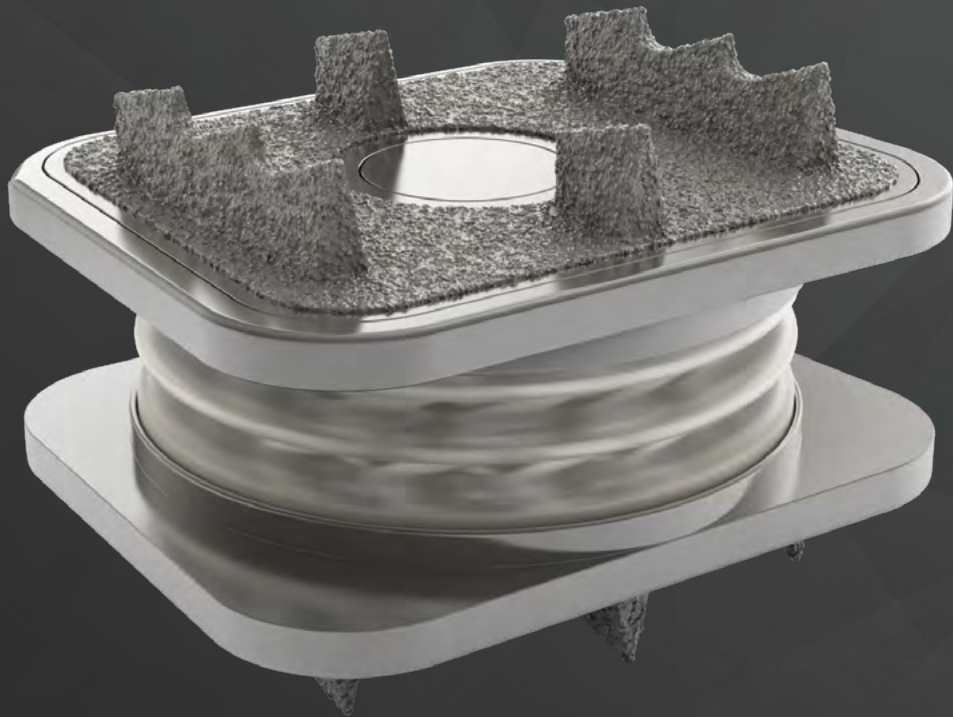

Table of Contents

1	The M6-C™ Artificial Cervical Disc
2	The M6-C™ Artificial Cervical Disc Surgical Instruments
3	Patient Positioning
4	Surgical Approach and Procedure
5	Midline Identification and Placement of the Cervical Retainer Pins
6	Discectomy and Decompression
7	Intervertebral Distraction
9	Reassessment of Midline
9	Footprint Sizing
11	Trial Assessment: Disc Height
12	Trial Assessment: Midline Location
13	Cutting Fin Tracks
14	Loading the M6-C™ Artificial Cervical Disc onto the Inserter
15	The M6-C™ Artificial Cervical Disc Insertion
17	Final Implant Assessment
18	The M6-C™ Artificial Cervical Disc Explantation
23	The M6-C™ Artificial Cervical Disc and Surgical Instrument Reference
27	Use Guide for the M6-C™ Artificial Cervical Disc

The surgical technique shown is for illustrative purposes only. The technique(s) actually employed in each case will always depend upon the medical judgment of the surgeon exercised before and during surgery as to the best mode of treatment for each patient. Please see the Instructions For Use for the complete list of indications, warnings, precautions, and other important medical information.

M6[®]
artificial cervical disc

The M6-C Artificial Cervical Disc

DEVICE DESCRIPTION

The M6-C™ Artificial Cervical Disc is an intervertebral disc prosthesis designed to permit motion of a functional spinal unit in the cervical spine when replacing a degenerated native disc. The device is comprised of ultra-high molecular weight polyethylene (UHMWPE) fiber wound in a specific pattern, with multiple redundant layers, creating a fiber matrix (artificial annulus). The fiber is wound around a polycarbonate urethane polymer (PCU) core (artificial nucleus) and through the slots in two Ti6Al4V titanium alloy inner endplates. The core is situated between and in contact with the two inner endplates, but not affixed to them. A PCU sheath surrounds the fiber matrix and is retained by two Ti6Al4V weld bands that are welded to the inner endplates. Two Ti6Al4V outer endplates are also welded to the inner endplates. The exterior surfaces of the outer endplates include low profile fins and are coated with titanium plasma spray (TPS).

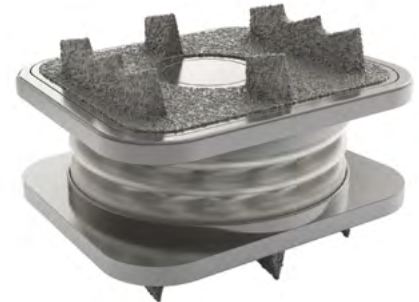

The M6-C™ Artificial Cervical Disc is designed to maintain the natural behavior of a functional spinal unit by replicating the biomechanical characteristics of the native disc. This design enables the M6-C™ Artificial Cervical Disc to move in all six degrees of freedom, with independent angular rotations (flexion-extension, lateral bending and axial rotation) along with independent translational motions (anterior-posterior and lateral translations as well as axial compression). The device is intended to replicate the physiological phenomenon of progressive resistance to motion in all six degrees of freedom. The sheath is designed to minimize any tissue ingrowth as well as the migration of wear debris. The serrated fins provide acute fixation to the superior and inferior vertebral bodies. The TPS coating increases the bone contact surface area.



The surgical implantation of the M6-C™ Artificial Cervical Disc requires specific surgical instruments including a Footprint Template and a Trial to determine the appropriate size and position of the implant; a Fin Cutter to create Fin tracks in the superior and inferior vertebral endplates; and an Inserter to place the M6-C™ Artificial Cervical Disc into the desired position and to aid in and ensure correct placement within the intervertebral space. Additionally, there are general surgical instruments to assist in the distraction and mobilization of the disc space.

The instruments are composed primarily of surgical stainless steel, with some instrument handles also featuring aluminum and Radel materials. Surgical instruments are provided non-sterile and are intended to be reusable.

The M6-C™ Artificial Cervical Disc should only be used by surgeons who are experienced in the surgical procedure and have undergone adequate training with this device. A lack of adequate experience and/ or training may lead to a higher incidence of adverse events, such as vascular or neurological complications.

CAUTION: Read and understand the M6-C™ Artificial Cervical Disc Instructions for Use prior to use.

The M6-C Artificial Cervical Disc Surgical Instruments

HEIGHTS & FOOTPRINT SIZES

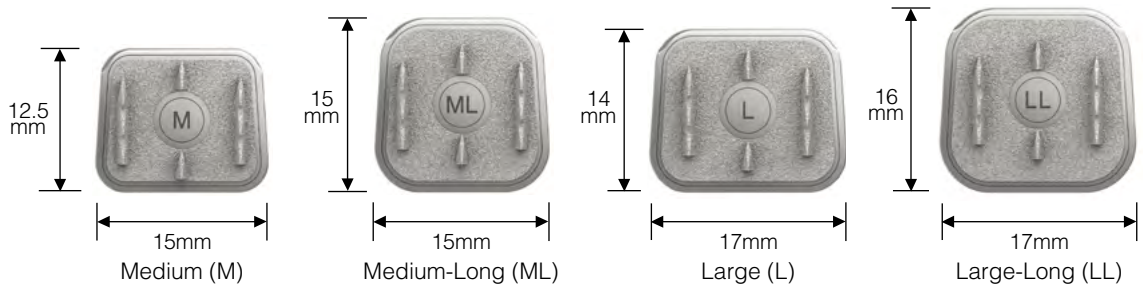
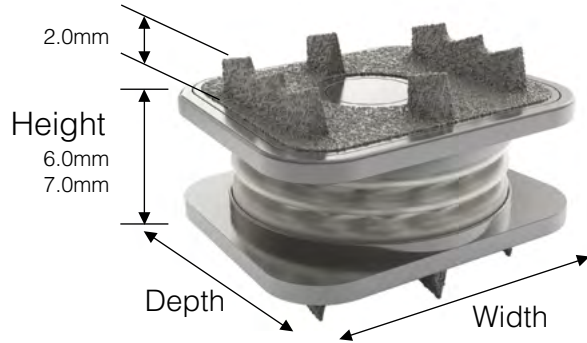

THE M6-C SURGICAL INSTRUMENTS

Please refer to page 23 for a complete list of the M6-C™ Artificial Cervical Disc Surgical Instruments and catalog numbers.

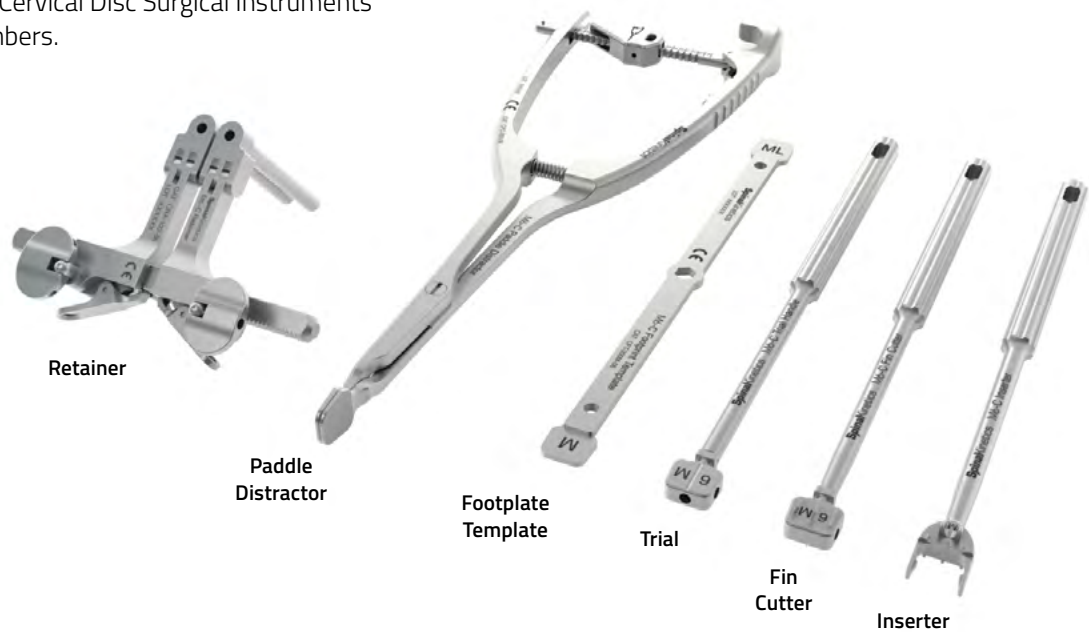

PATIENT POSITIONING

Appropriate patient positioning is critical to ensure proper placement of the M6-C™ Artificial Cervical Disc upon implantation in the cervical spine.

- With the patient placed in the supine position, make sure the head and neck are in a neutral position and avoid hyperextension. The posterior cervical spine should be supported (i.e. soft roll) to help maintain this neutral position throughout the procedure. (Fig. A)
- Confirm the neutral position via fluoroscopy (Figs. B & C)
- At the discretion of the surgeon, secure or tape the head to prevent unwanted movement. Maintaining proper alignment and eliminating rotation of the spine throughout the procedure is critical.
- If operating at the lower levels of the cervical spine (C6/C7), it is highly recommended that the patient's shoulders be pulled down for better fluoroscopic visualization of the entire cervical spine.



Fig. A

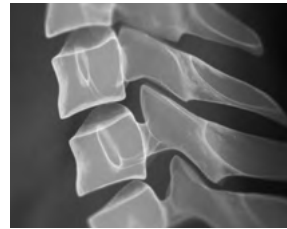

Fig. B

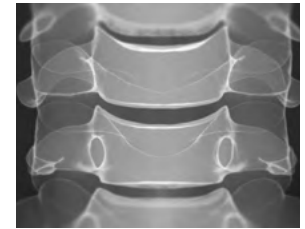

Fig. C

SURGICAL APPROACH AND PROCEDURE

An artificial cervical disc implantation procedure utilizes a similar surgical approach to that of anterior cervical discectomy and fusion (ACDF). Using either a right or left-side approach and standard anterior cervical technique, dissect down to the treatment level, and confirm the target disc space with fluoroscopy.

There are, however, key surgical considerations for artificial cervical disc replacement that differ from ACDF. As a result, the operating surgeon must keep the following in mind:

- Identify and mark midline.
- Achieve parallel distraction with the Interbody Distractor.
- Anterior to posterior disc space mobilization is essential.
- Bilateral-symmetrical decompression of the foramen is critical.
- Preserve as much bony endplate as possible while still adequately preparing the disc space.
- Minimize bleeding bone.
- Maximize A/P and lateral coverage of the vertebral endplate by selecting the appropriate M6-C™ Artificial Cervical Disc footprint (use the Footprint Template).
- Re-establish anterior and posterior disc height (do not over-distract).
- Final placement of the implant should be as close as possible to the posterior vertebral margin.

WARNING: During implantation, the surgeon should ensure that none of the surgical instruments or the M6-C™ Artificial Cervical Disc progress beyond the posterior border of the vertebral bodies. Due to the proximity of vascular and neurological structures to the implantation site, there are risks of serious or fatal hemorrhage and risks of neurological damage with the use of this device, and allowing the instruments or the M6-C™ Artificial Cervical Disc to progress beyond the posterior border of the vertebrae may result in injury to these structures.

WARNING: Fluoroscopic confirmation of positioning of certain instruments and the implant should be performed during the surgical procedure. Failure to confirm position of instruments and the implant during the surgical implantation procedure may result in patient injury.

NOTE: The M6-C™ Artificial Cervical Disc is designed to be implanted with the device endplates parallel to each other. Excessive lordosis or kyphosis can lead to less than optimal M6-C™ Artificial Cervical Disc performance.

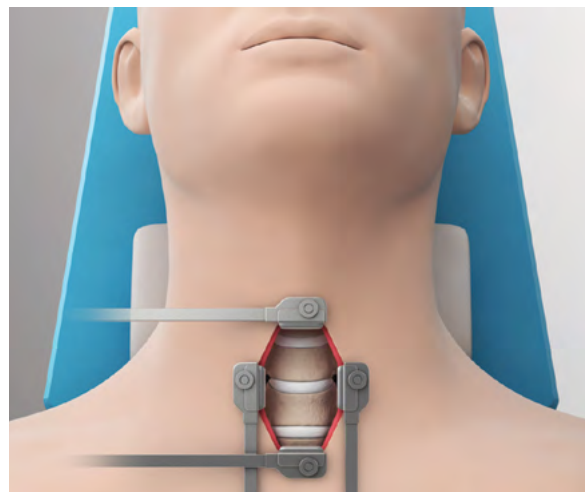
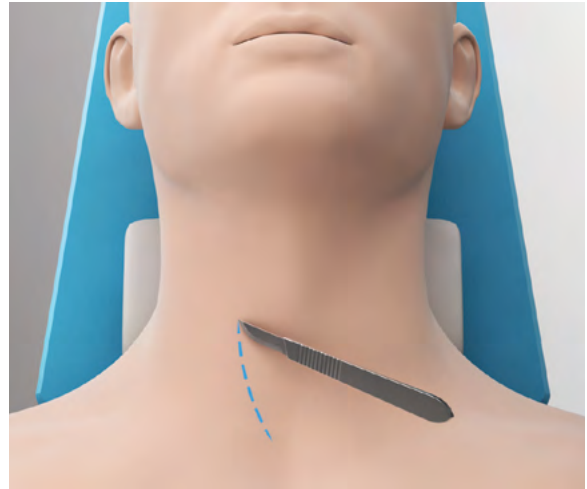

MIDLINE IDENTIFICATION AND PLACEMENT OF THE CERVICAL RETAINER PINS

Use careful dissection to preserve the longus colli muscles for use as an initial midline reference.

- Using A/P and lateral fluoroscopic guidance, identify the center of the vertebral body and select the appropriate **Cervical Retainer Pin (12mm: CRP-012-04, 14mm: CRP-014-04 or 16mm: CRP-016-04)**.
- Insert the Retainer Pins with the **Pin Driver (RPD-100-06)**. Attention to proper Retainer Pin placement is important. If properly placed, the Retainer Pins can provide a visual reference for midline and disc space trajectory for subsequent steps during implantation of the M6-C™ Artificial Cervical Disc.

The following steps should be followed when placing Retainer Pins:

- Use careful dissection to preserve the longus colli muscles for use as an initial midline reference.
- Using A/P fluoroscopic guidance, identify the midline of the vertebral body.
- Assess the depth of the vertebral body and select the appropriate Retainer Pin using fluoroscopy as needed.
- Center the Retainer Pins on midline in the coronal plane. (Fig. A)
- Insert the Retainer Pins with the Pin Driver.
- Do not place the Retainer Pins too close to the disc space, as this can lead to instrument interference when the Retainer is in place.
- The Retainer Pins should be inserted parallel to their respective endplate in order to ensure parallel distraction of the disc space. (Fig. B)



Fig. A

Center the Retainer Pins on the vertebral bodies in the coronal plane.

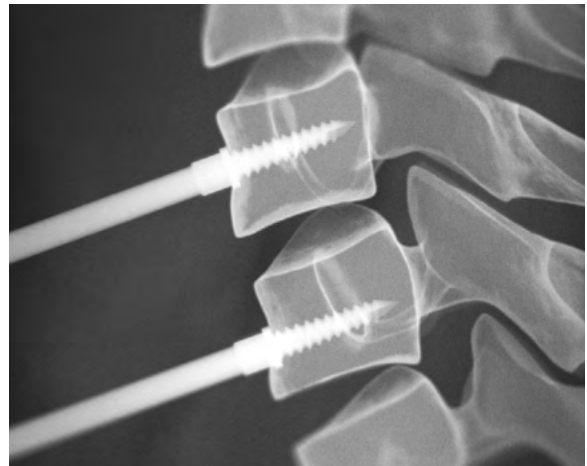

Fig. B

The Retainer Pins should be placed parallel to their respective endplates

DISCECTOMY AND DECOMPRESSION

- Place the **Retainer (CRA-100-06)** on the Retainer Pins, and open it to the desired height for performing the discectomy. Use the **Cervical Retainer Locking Nuts (CRN-100-04)** to secure the Retainer to the Retainer Pins.
- Perform a complete discectomy between the uncovertebral joints and back to the posterior longitudinal ligament. A total, bilateral symmetrical decompression should be performed.

NOTE: *If the uncinates require remodeling, dissection should always be bilateral and symmetrical. Failure to perform a bilateral symmetrical resection could result in implant position and/or endplate angles that are sub-optimal.*

NOTE: *Release of the posterior longitudinal ligament (PLL) may aid in posterior mobilization of the disc space and obtaining parallel distraction. Release should be bilaterally symmetrical.*

- Use standard instruments to remove anterior and posterior osteophytes to ensure proper disc placement and decompression.
- Use standard instruments to remove the cartilaginous endplates.

NOTE: *Using the Retainer and Cervical Retainer Pins as distraction devices may not result in parallel distraction.*

CAUTION: *Excessive removal of endplate cortical bone may result in sub-optimal outcomes. Take care to preserve cortical bone and maintain vertebral endplate angles as much as possible. Excessive preparation of the endplate can result in suboptimal outcomes (e.g. subsidence, loss of disc space height). In addition, excessive removal of anterior or posterior bone may result in abnormal disc space angles (e.g. kyphosis, hyper-lordosis).*

INTERVERTEBRAL DISTRACTION

It is important to achieve parallel distraction to restore optimal disc height anterior to posterior. The **Paddle Distractor (CPD-200-06)** is used to help achieve parallel distraction of the disc space. As a reference, the footprint of the Paddle is 15mm x 15mm, the same dimensions as the Medium-Long M6-C™ Artificial Cervical Disc.

NOTE: A lack of posterior disc height restoration, as well as insufficient mobilization, may result in sub-optimal M6-C™ Artificial Cervical Disc endplate positioning and abnormal endplate angles. This may lead to less than optimal M6-C™ Artificial Cervical Disc performance.

- Under fluoroscopic guidance, insert the Paddle Distractor into the disc space. Care should be taken not to advance the end of the Paddle beyond the posterior vertebral margin. (Fig. A)
- The Paddle Distractor may be used with or without the height limiter engaged. If desired, select the distraction height limit by choosing the number in the limiter window.
- Release any distraction on the Retainer.
- Open the Paddle Distractor to the desired height, and mobilize the disc space as needed. (Fig. B)

The Paddle Distractor can also be used with the **Distractor Spacer (CDS-100-06)**. Use the Distractor Spacer to assist in controlled restoration of the desired height and disc space mobilization. The Distractor Spacer and Paddles combine to achieve heights between 5mm (flat) and 7mm (perpendicular to the Paddles).

- Open the Paddle Distractor and insert the flat Distractor Spacer between the Distractor Paddles. (Fig. C)
- Rotating the Distractor Spacer between the Paddle Distractor endplates will achieve a distraction height between 5mm and 7mm. (Fig. D)

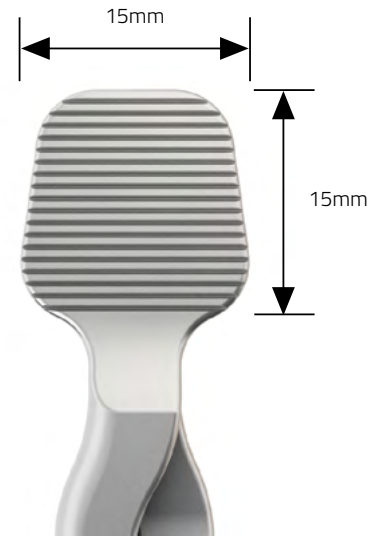

The Paddle Distractor footprint dimensions are the same as the Medium-Long M6-C™.

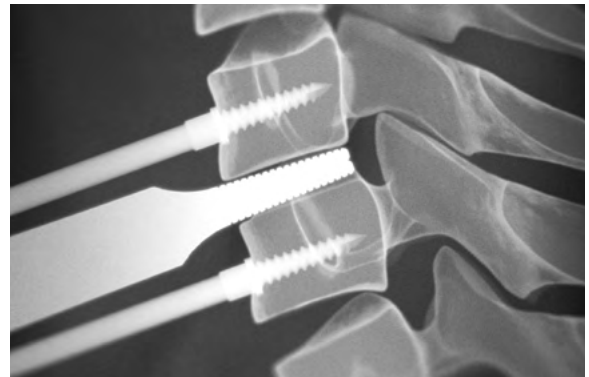

Fig. A

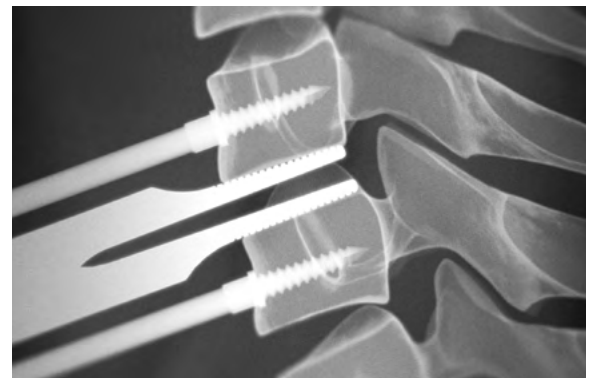

Fig. B

- Repeat the above step on the opposite side to achieve equal bilateral mobilization.
- Once proper height restoration and mobilization have been achieved with the Paddle Distractor, use the Retainer to maintain the desired disc space height.
- The **Intervertebral Distractor (CPD-100-06)** can also be used to restore desired height and to mobilize the disc space as needed.

CAUTION: Take care not to over-distract the disc space.

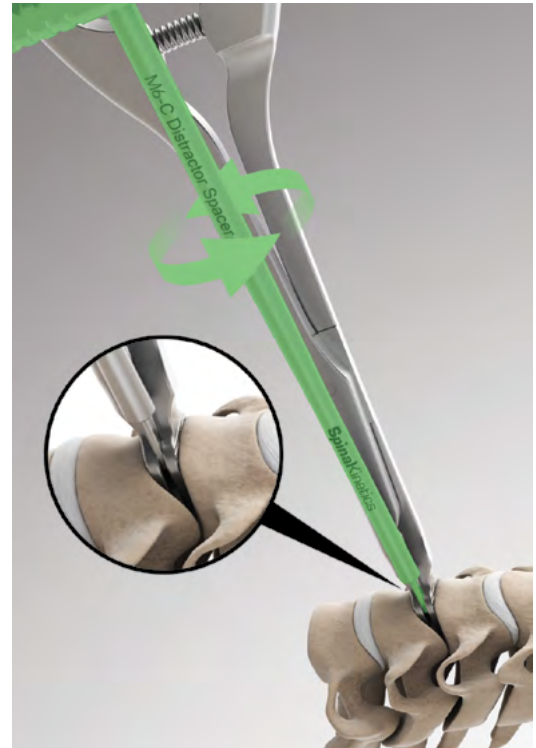

Fig. C



Fig. D

Use of the Paddle Distractor with the Distractor Spacer will help facilitate necessary height restoration and optimal bilateral disc space mobilization.

REASSESSMENT OF MIDLINE

- Visualize the medial aspect of the uncovertebral joints.
- Confirm that the Retainer Pins are in the midline as indicated by the point midway between the medial uncinates. If necessary, mark a corrected midline reference on the anterior vertebral bodies.

FOOTPRINT SIZING

The Footprint Template is used to determine endplate sizing as well as aid in evaluating endplate preparation. The largest M6-C™ Artificial Cervical Disc footprint should always be used to cover as much of the vertebral endplate as possible.

Optimal positioning for the M6-C™ Artificial Cervical Disc is on the cortical rim of the vertebral body and symmetrically between the uncinates. (Fig. A)

- Under fluoroscopic guidance and visualization, use the **Footprint Template** to determine the correct size (Medium: 12.5mm x 15mm, Medium-Long: 15mm x 15mm: **CFT-200M-06**, Large: 14mm x 17mm, Large-Long: 16mm x 17mm: **CFT-200L-06**).
- To determine the optimal M6-C™ Artificial Cervical Disc size that will provide maximum endplate coverage anterior to posterior, lay the Footprint Template onto the prepared vertebral endplate. The ledge on the Footprint Template represents the anterior edge of the M6-C™ Artificial Cervical Disc. Use this reference to ensure the M6-C™ Artificial Cervical Disc will be placed inside the anterior vertebral margin. The posterior edge of the Footprint Template should come as close as possible to the posterior vertebral margin. (Figs. B & C)



Fig. A

Choose the largest possible M6-C™ footprint to cover the entire vertebral body. Placement should be on the cortical rim, symmetrically between uncinates.

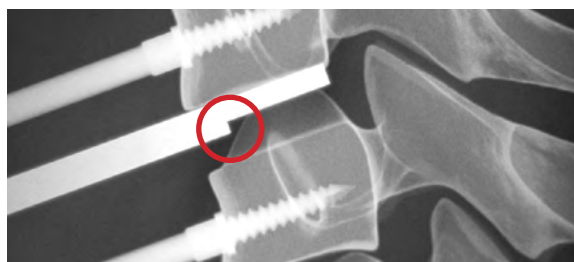

Fig. B

Sub-optimal footprint coverage: The Footprint Template ledge is not aligned with the anterior margin of the vertebra. The selected Footprint Template is too small.

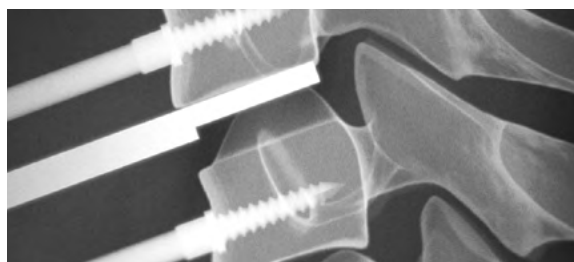

Fig. C

Optimal footprint coverage.

- Slowly transition the Footprint Template anterior to posterior along the vertebral endplate. Feel for any bony obstructions that may be hindering advancement of the Footprint Template posteriorly. Use standard instruments to remove any bony obstructions or osteophytes that may impede the movement of the Footprint Template. (Fig. D)
- Slight flattening of the vertebral endplates may be needed to maximize M6-C™ Artificial Cervical Disc endplate coverage and acute fixation. (Fig. E)

NOTE: *Bony obstructions identified by the Footprint Template that are not reduced could impede insertion of the Trial and the M6-C™ Artificial Cervical Disc, as well as influence final positioning of the implant on the vertebral endplates.*

- After achieving maximum anterior to posterior coverage, slight symmetrical resection of the uncinete processes may be needed to allow the Footprint Template to fit correctly across the width of the disc space. This allows the M6-C™ Artificial Cervical Disc to be seated appropriately between the uncovertebral joints and minimizes the impaction force needed to position the implant. (Fig. F)

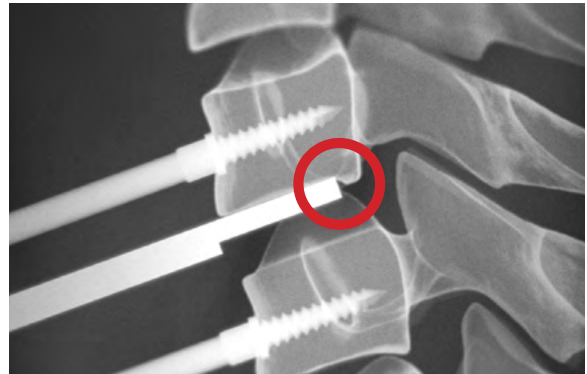

Fig. D

Bony obstruction limiting A/P coverage.

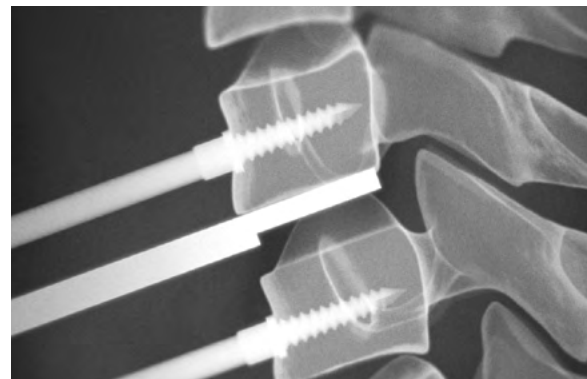

Fig. E

Slight flattening of the vertebral endplates may be needed to help minimize obstructions.



Fig. F

Optimal and symmetrical fit between the uncinate. Slight symmetrical resection of the uncinate may be necessary to achieve optimal fit.

TRIAL ASSESSMENT: DISC HEIGHT

The Footprint Template will aid in the determination of the optimal **Trial Head (CTH-XXX-06)** footprint to use. 6mm and 7mm heights are available in all footprints. Start with the 6mm height, and then increase if necessary. Do not over-distraction the disc space compared to adjacent levels.

- Thread the **Trial Handle (CIH-100-06)** onto the appropriate 6mm Trial Head.
- Align the Midline Marking Guide of the Trial Head to the midline of the targeted vertebral bodies. The Midline Marking Guide may be oriented either caudal or cephalad.
- Use the **Mallet (CIM-100-06)** to carefully tap the appropriate Trial Head into the disc space under close fluoroscopic guidance.

NOTE: *Slight distraction may assist in introducing the Trial Head into the disc space.*

- Advance the Trial into the disc space while observing the progress on lateral fluoroscopy. The **Center Alignment Port (CAP)** (Fig. A) on the Trial can be used to align the C-Arm to the disc space and the Trial Head. Advance the Trial until the posterior edge of the Trial Head reaches the posterior margin of the vertebral body.

NOTE: *The Trial should be positioned so that it rests on cortical bone. Ensure all external distraction has been released when assessing final fit of the Trial.*

- With the 6mm Trial in place, observe the disc space height, facet joints and spinous process, and compare to adjacent levels. There should be good correlation of adjacent level height with the index level and no over-distraction of the disc space. (Fig. B)
- With the desired A/P position confirmed, use electrocautery to mark the vertebra at the center of the Midline Marking Guide.
- If additional height is desired, repeat the above steps using the 7mm Trial Head.

NOTE: *Performing final Trial assessment with external distraction engaged may result in an inappropriate height selection.*

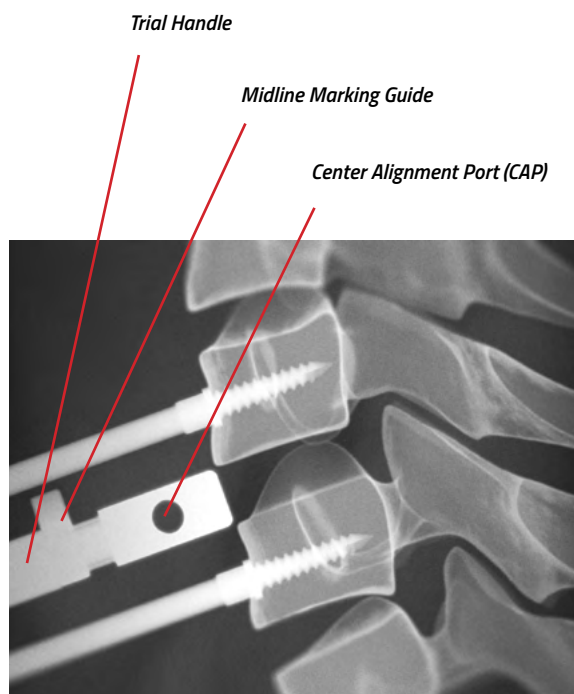

Fig. A

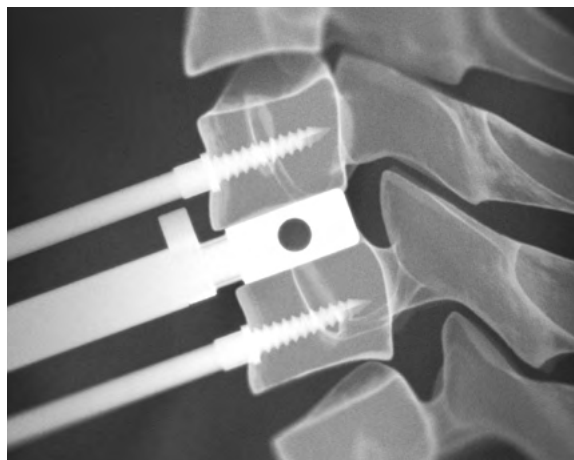

Fig. B

TRIAL ASSESSMENT: MIDLINE LOCATION

- Remove the Trial Handle from the Trial Head.
- Place the C-Arm into the A/P position and align it to the spine using the spinous processes and lateral vertebral anatomy as a rotational reference. The Center Alignment Port (CAP) will allow quick angular alignment of the C-Arm to the plane of the disc space. (Figs. A & B)
- Once the C-Arm is aligned to the spine and disc space, use fluoroscopy to visualize the Trial in relation to the uncovertebral joints and confirm that it is in the midline.
- Make any necessary adjustments to the Trial with the C-Arm in the A/P position.
- Use electrocautery to mark the vertebra at the center of the Midline Marking Guide if this position is different from previously determined locations.
- Before removing the Trial Head, return the C-Arm to the lateral position, and re-align to the lateral CAP.
- Lock the C-Arm in this position. Use this C-Arm position for the Fin track cutting and implantation steps.
- Re-thread the Trial Handle back onto the Trial Head in the disc space.
- Remove the Trial from the disc space. A gentle right-to-left and pulling up motion may facilitate removal.

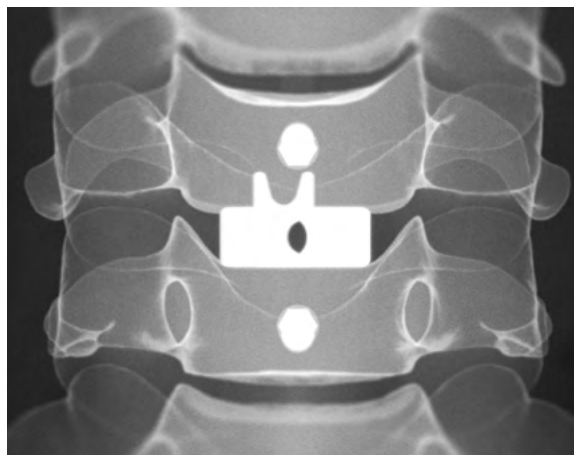

Fig. A
Misaligned Trial

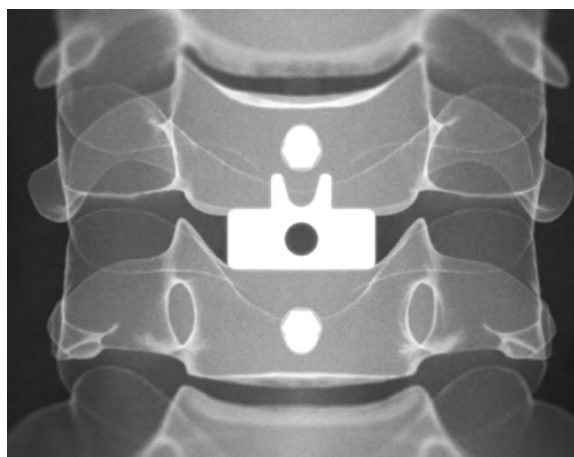

Fig. B
Properly Aligned Trial

CUTTING FIN TRACKS

- Select the correct **Fin Cutter (CIC-XXX-06)** size based on the final footprint and height sizing.
- Align the Midline Marking Guide of the Fin Cutter to the midline reference. Orient the Midline Marking Guide on the Fin Cutter in the same caudal or cephalad direction used with the Trial. (Figs. A & B)

NOTE: Slight distraction may assist in introducing the Fin Cutter into the disc space.

- Angle the handle of the Fin Cutter to match the trajectory of the disc space as viewed on lateral plane fluoroscopy. If correctly aligned, the Retaining Pins may also be used as a guide. (Fig. C)
- Using fluoroscopic guidance, carefully tap the Fin Cutter into the disc space while maintaining the midline and handle references previously made.
- Release all distraction after the Fin Cutter has been introduced into the disc space.

NOTE: Any external distraction during Fin cutting may adversely affect the depth of the Fin tracks. Insufficient Fin track depth may result in suboptimal acute fixation of the implant.

- Advance the Fin Cutter into the disc space under fluoroscopic guidance until it reaches the same posterior position as the Trial in the previous step.
- Remove the Fin Cutter using the **Slide Hammer (CSH-100-06)**.
- Inspect the Fin tracks upon removal of Fin Cutter. Clean any bony remnants out of the tracks, and then thoroughly irrigate and suction the disc space to remove any loose particles.

NOTE: Do not allow the Fin Cutter to progress beyond the desired location of the M6-C™ Artificial Cervical Disc.

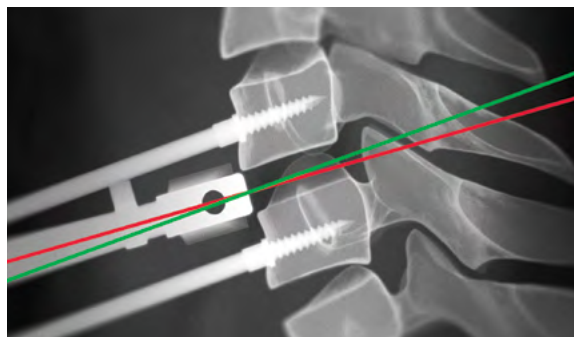

Fig. A

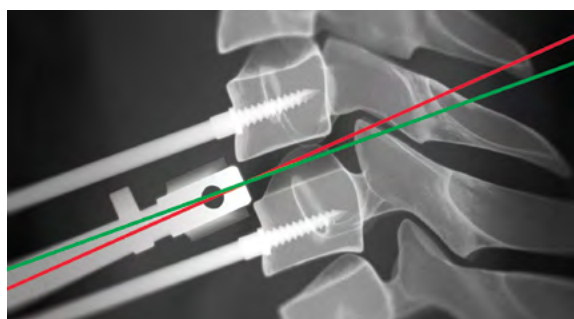

Fig. B

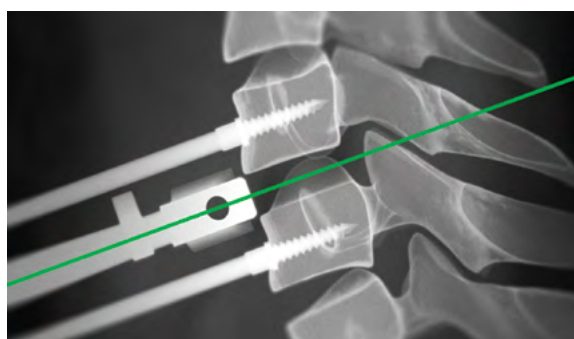
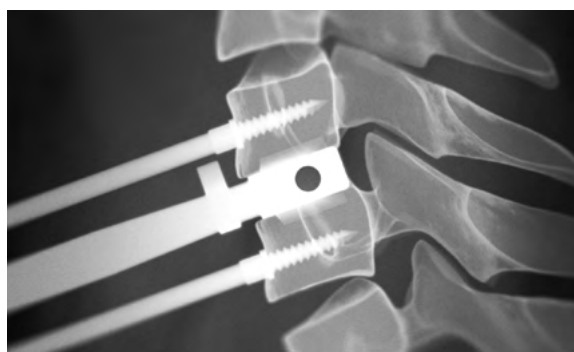

Fig. C



Match the trajectory of the disc space when inserting the Fin Cutter.

LOADING THE M6-C ARTIFICIAL CERVICAL DISC ONTO THE INSERTER

- Select the appropriate **Inserter Tool (CII-XXX-06: Medium, Medium-Long, Large, Large-Long)**.
- Place the Inserter onto the M6-C™ Artificial Cervical Disc without removing the device from the Packaging Clip. (Figs. A & B)
- Once the inserter is in place, flip the toggle to release the M6-C™ Artificial Cervical Disc from the Packaging Clip. (Fig. C)
- Remove the M6-C™ Artificial Cervical Disc from the Packaging Clip. (Fig. D)
- Confirm that the anterior edge of the M6-C™ Artificial Cervical Disc endplate is flush against the Inserter. (Fig. E)
- The M6-C™ Artificial Cervical Disc is now loaded and ready to insert.



Fig. A



Fig. B



Fig. C



Fig. D



Fig. E

THE M6-C ARTIFICIAL CERVICAL DISC INSERTION

- Align the middle Fixation Fins of the M6-C™ Artificial Cervical Disc to the middle Fin tracks created by the Fin Cutter. Orient the handle of the Inserter to the trajectory of the disc space as viewed on lateral plane fluoroscopy. (Figs. A & B)

NOTE: Slight distraction may assist in introducing the Inserter/M6-C™ Artificial Cervical Disc into the disc space.

- Carefully tap the Inserter/M6-C™ Artificial Cervical Disc into the disc space while keeping the Fixation Fins aligned to the Fin tracks. (Figs. B & C)

NOTE: It is important to make sure that the three Fins on each of the M6-C™ Artificial Cervical Disc endplates are accurately aligned to the three tracks that were created by the Fin Cutter on each vertebral body. Failure to align the correct Fins to the corresponding tracks will result in sub-optimal placement of the implant.

- Release all distraction after initial introduction of the Inserter/M6-C™ Artificial Cervical Disc into the disc space.
- Continue carefully advancing the Inserter/M6-C™ Artificial Cervical Disc while observing the progress via lateral fluoroscopy until the posterior edge of the M6-C™ Artificial Cervical Disc reaches the desired location. (Fig. D)
- Verify that the M6-C™ Artificial Cervical Disc is at the desired anterior/ posterior position before removing the Inserter.
- Remove the Inserter while using a gentle right-to-left and pulling up motion.

NOTE: If the Inserter must be re-attached for additional posterior placement, make sure that both the upper and lower endplates of the M6-C™ Artificial Cervical Disc are in good contact with the Inserter.

A slight amount of external distraction may be necessary in order to completely reattach the Inserter. Release the external distraction prior to attempting further positioning.



Fig. A

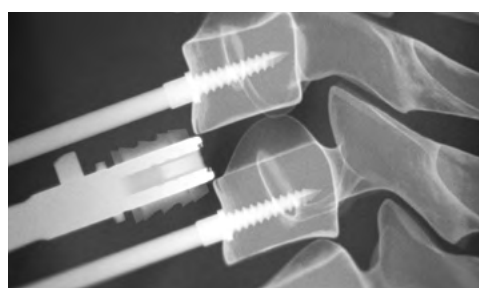

Fig. B

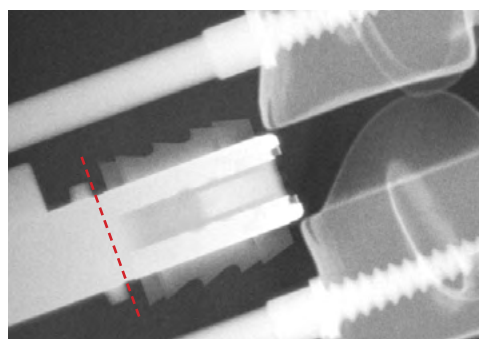

Fig. C

M6-C™ Artificial Cervical Disc anterior edge

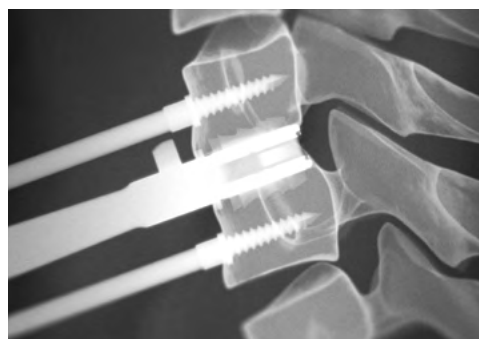

Fig. D

The leading edge of the M6-C™ Artificial Cervical Disc endplate should be viewed as a reference to determine optimal posterior placement.

The **Offset Tamp (CTI-100-06)** may be utilized after implantation if there is a need to selectively advance either the superior or inferior endplate of the M6-C™ Artificial Cervical Disc posteriorly. (Fig. E)

- Insert the Offset Tamp onto the implanted M6-C™ Artificial Cervical Disc with the arrow on the head of the Tamp against the endplate that is to be moved posteriorly. The Tamp is designed to advance the selected endplate no more than 1mm. (Fig. E)
- Using fluoroscopic guidance, carefully tap the Offset Tamp/M6-C™ Artificial Cervical Disc endplate into the disc space until the posterior edge of the selected endplate achieves the desired position or reaches its maximum of 1mm.
- Verify that the M6-C™ Artificial Cervical Disc endplate/disc is at the desired position before removing the Tamp.

NOTE: Do not advance the Offset Tamp if it is touching both endplates of the M6-C™ Artificial Cervical Disc.

NOTE: The M6-C™ Artificial Cervical Disc should not be placed more posteriorly than the final posterior position obtained by the Fin Cutter.

NOTE: The M6-C™ Artificial Cervical Disc cannot be repositioned anteriorly. Take care not to place the M6-C™ Artificial Cervical Disc beyond the desired posterior position.



Fig. E

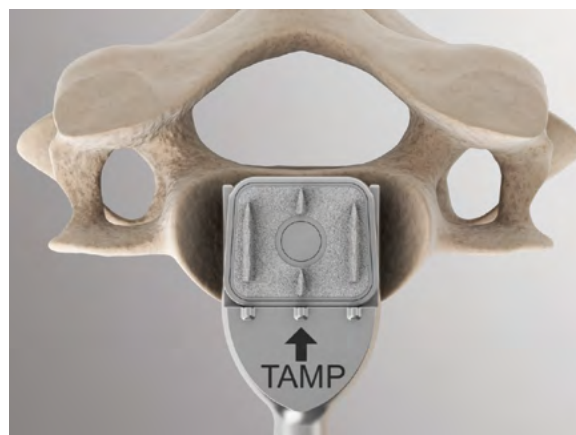

Fig. F

Align arrow on Tamp head to M6-C™ Artificial Cervical Disc endplate to be moved.

FINAL IMPLANT ASSESSMENT

- Use fluoroscopy to assess the final placement of the M6-C™ Artificial Cervical Disc in both A/P and lateral views. (Figs. A & B)
- Once the final placement has been confirmed, remove the Retainer and Retainer Pins.
- Minimize any bleeding and close the wound using standard practices.

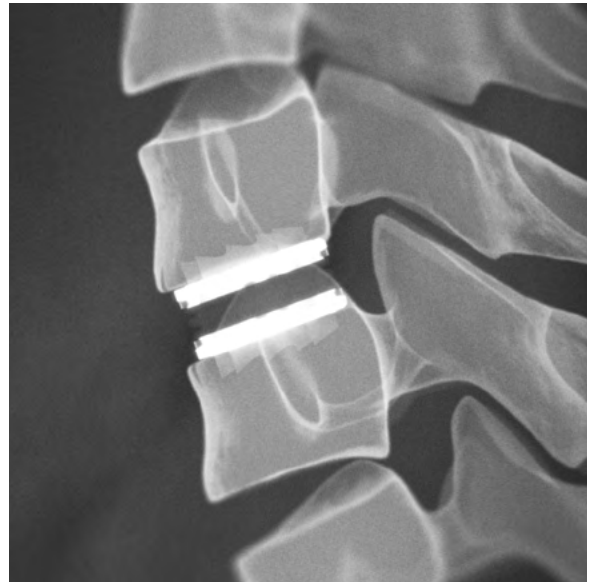

Fig. A

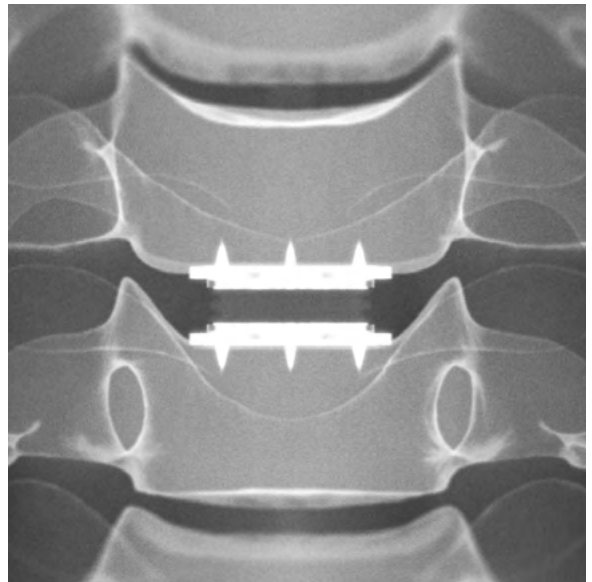

Fig. B

THE M6-C ARTIFICIAL CERVICAL DISC EXPLANATION

The **Acute Disc Removal Tool** (Fig.A) can aid the surgeon in situations where the implant has been placed in a suboptimal position and needs to be removed from the intervertebral space.

This instrument is designed and intended to fully remove the implant and not to reposition the M6-C™ Artificial Cervical Disc. The Acute Disc Removal Tool is designed to couple with the M6-C™ Artificial Cervical Disc endplates in normal alignment.

An implant with excessively lordotic, kyphotic or translated endplates may not couple with the removal tool. Excessive soft tissue near the lateral edges of the M6-C™ Artificial Cervical Disc may hinder the ability of the Acute Disc Removal Tool to couple with the implant. The Acute Disc Removal Tool should not be used to advance the M6-C™ Artificial Cervical Disc into the disc space. Do not use the hammer against the locking key or handle.

Select the appropriately sized Removal Tool based on the size of the implant (Fig. B):

- **CDR-100M-06:** M/ML for Medium and Medium-Long M6-C™ Artificial Cervical Discs
- **CDR-100L-06:** L/LL for Large and Large-Long M6-C™ Artificial Cervical Discs

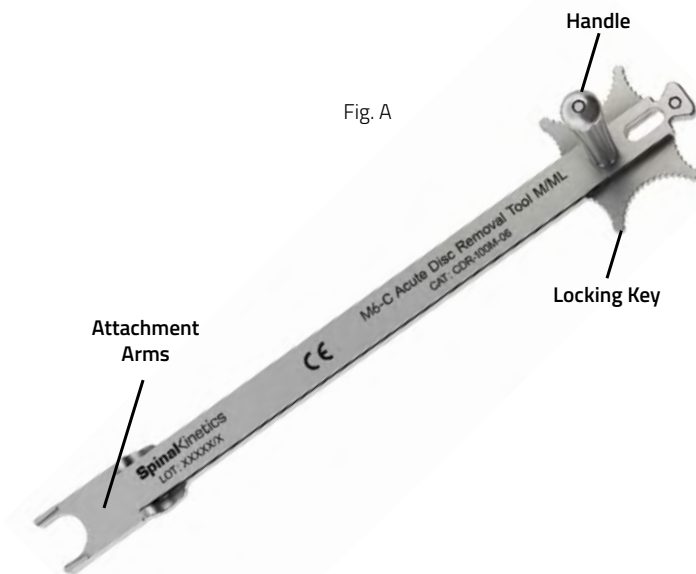

Fig. A

Fig. B



Endplate engagement



No Attachment Arm engagement



No Endplate engagement

Slide the Locking Key of the Removal Tool backwards (towards the operator). (Figs. C & D)



Fig. C



Fig. D

Lightly pinch the two Attachment Arms together and insert them between the endplates of the M6-C™ Artificial Cervical Disc. (Fig. E)



Fig. E

Ensure the Attachment Arms are fully seated onto the M6-C™ Artificial Cervical Disc. (Fig. F)

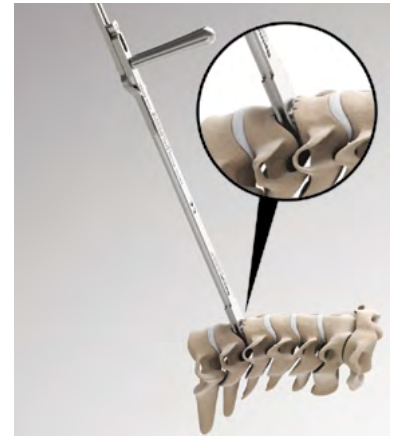

Fig. F

Holding onto the handle, manually slide the Locking Key down until the marks are aligned. (Figs. G, H, I). The marks must be aligned and the Attachment Arms should be in contact with both endplates of the M6-C™ Artificial Cervical Disc, (Fig. J) indicating that the removal tool is securely attached to the M6-C™ Artificial Cervical Disc. If the Attachment Arms are not in contact with the endplates, (Fig. K) the Removal Tool is not coupled securely with the M6-C™ Artificial Cervical Disc.

NOTE: Do not force or hammer the Locking Key down. If the Locking Key does not slide easily, gently rock the Removal Tool back and forth laterally while advancing the key in order to align the Removal Tool with the endplates of the M6-C™ Artificial Cervical Disc. The Removal Tool may need to be removed and repositioned.

NOTE: Rocking the Removal Tool back and forth laterally may assist in coupling. Additionally, bone or soft tissue on the lateral sides of the device may interfere with the secure coupling of the Removal Tool and the M6-C™ Artificial Cervical Disc.

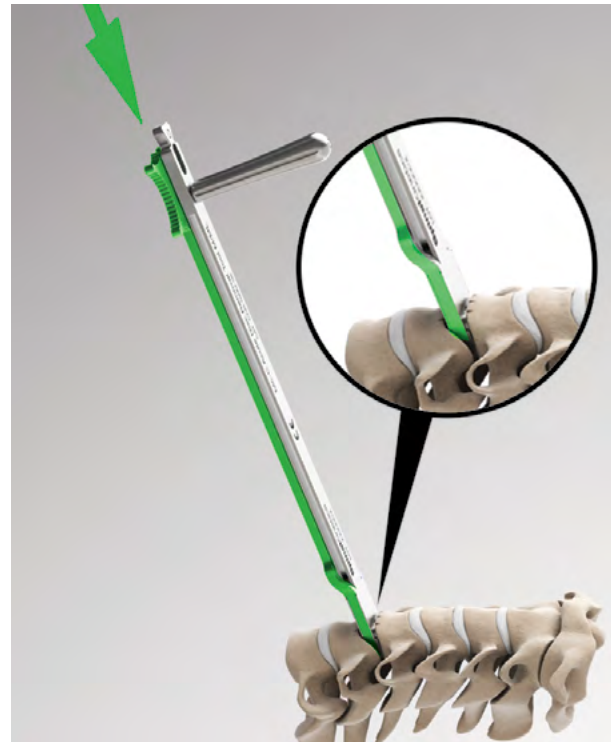

Fig. G

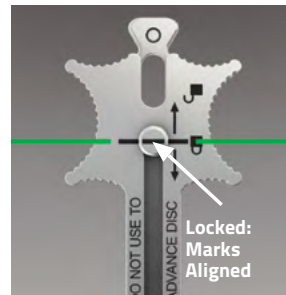

Fig. H

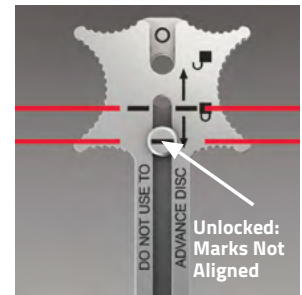

Fig. I



Fig. J



Fig. K

Once the marks are aligned on the Locking Key, engage the distal end of the Slide Hammer with the proximal end of the Removal Tool, and gently tap the Slide Hammer to remove the M6-C™ Artificial Cervical Disc from the disc space. (Fig. L)

Irrigate and suction to remove potential debris.

After removal of the implant, the surgeon's clinical judgement will dictate the proper method for stabilizing the disc space.

NOTE: Do not use a hammer to hit the handle of the Removal Tool to remove the M6-C™ Artificial Cervical Disc. This will unlock the device and cause the Removal Tool to lose engagement with the M6-C™ Artificial Cervical Disc.

NOTE: The Removal Tool should not be used to advance the M6-C™ Artificial Cervical Disc into the disc space.

WARNING: Surgical implants must never be reused or re-implanted. Even if the device appears undamaged, it may have small defects and internal stress patterns that can lead to early breakage.



Fig. L

If the Acute Disc Removal Tool cannot be used (e.g. revision surgery), the following steps should be followed to explant an M6-C™ Artificial Cervical Disc:

- Perform an anterior surgical approach to the involved level.
- Place the Retainer Pins into the adjacent vertebrae. Retainer Pins should be inserted parallel to one another.
- Introduce gentle distraction across the intervertebral space using the Retainer Pins.

If, in the surgeon's judgment, the device can safely be removed intact or without further disassembly:

- Carefully detach the device endplates from the vertebral endplates with elevators or other suitable instruments. Often a thin, narrow instrument such as a 3mm osteotome can be placed between the endplate (between the Fins) and the vertebral body to disrupt any bony on-growth.
- Care should be exercised not to over-distract the disc space.
- Once the bone interface has been disrupted, gently grasp the implant by the titanium endplates with forceps or other suitable instrument and remove.

If, in the surgeon's judgment, the device cannot be safely removed intact without the potential for over-distract and/or other harm to the patient:

- Cut a window in the M6-C™ Artificial Cervical Disc sheath with a scalpel.
- Carefully remove the sheath with forceps or other suitable instrument.
- Cut through the M6-C™ Artificial Cervical Disc fiber matrix with a scalpel to reveal the core.
- Remove the core with forceps or suitable instrument. Additional slight distraction may be needed. Take care not to over-distract.
- The device endplates can now be carefully detached from the vertebral endplates and then removed. Often a thin, narrow instrument such as a 3mm osteotome or other suitable instrument can be placed between the endplate (between the Fins) and the vertebral body to disrupt any bony on-growth.
- Irrigate and suction to remove potential debris.



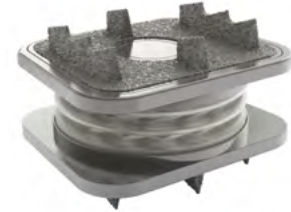

CAUTION: *Surgical implants must never be reused or re-implanted. Even though the device appears undamaged, it may have small defects and internal stress patterns that may lead to early breakage.*

M6-C Artificial Cervical Disc





CATALOGUE #	DESCRIPTION/IMPLANT SIZE
CDM-625	M6-C™ Artificial Cervical Disc, 6M (6mm H x 15mm W x 12.5mm D)
CDM-635L	M6-C™ Artificial Cervical Disc, 6ML (6mm H x 15mm W x 15mm D)
CDL-627	M6-C™ Artificial Cervical Disc, 6L (6mm H x 17mm W x 14mm D)
CDL-637L	M6-C™ Artificial Cervical Disc, 6LL (6mm H x 17mm W x 16mm D)
CDM-725	M6-C™ Artificial Cervical Disc, 7M (7mm H x 15mm W x 12.5mm D)
CDM-735L	M6-C™ Artificial Cervical Disc, 7ML (7mm H x 15mm W x 15mm D)
CDL-727	M6-C™ Artificial Cervical Disc, 7L (7mm H x 17mm W x 14mm D)
CDL-737L	M6-C™ Artificial Cervical Disc, 7LL (7mm H x 17mm W x 16mm D)



M6-C Artificial Cervical Disc Surgical Instruments

CATALOGUE #	DESCRIPTION	INSTRUMENT LABEL
CRP-012-04	Cervical Retainer Pin, 12mm	 1
CRP-014-04	Cervical Retainer Pin, 14mm	
CRP-016-04	Cervical Retainer Pin, 16mm	
RPD-100-06	Pin Driver	 2
CRA-100-06	Retainer	 3
CRN-100-04	Cervical Retainer Locking Nut	 4

M6-C Artificial Cervical Disc Surgical Instruments

CATALOGUE #	DESCRIPTION	INSTRUMENT	LABEL
CPD-200-06	Paddle Distractor		5
CDS-100-06	Distractor Spacer		6
CPD-100-06	Intervertebral Distractor		7
CFT-200M-06	Footprint Template M/ML		8
CFT-200L-06	Footprint Template L/LL		
CTH-615-06	Trial Head, 6M (6mm H x 15mm W x 12.5mm D)		9
CTH-615L-06	Trial Head, 6ML (6mm H x 15mm W x 15mm D)		
CTH-617-06	Trial Head, 6L (6mm H x 17mm W x 14mm D)		
CTH-617L-06	Trial Head, 6LL (6mm H x 17mm W x 16mm D)		
CTH-715-06	Trial Head, 7M (7mm H x 15mm W x 12.5mm D)		
CTH-715L-06	Trial Head, 7ML (7mm H x 15mm W x 15mm D)		
CTH-717-06	Trial Head, 7L (7mm H x 17mm W x 14mm D)		
CTH-717L-06	Trial Head, 7LL (7mm H x 17mm W x 16mm D)		

M6-C Artificial Cervical Disc Surgical Instruments

CATALOGUE #	DESCRIPTION	INSTRUMENT	LABEL
-------------	-------------	------------	-------

CIH-100-06	Trial Handle		10
------------	--------------	--	----



CIM-100-06	Mallet		11
------------	--------	--	----



CIC-615-06	Fin Cutter, 6M (6mm H x 15mm W x 12.5mm D)		12
------------	--	--	----

CIC-615L-06	Fin Cutter, 6ML (6mm H x 15mm W x 15mm D)
-------------	---

CIC-617-06	Fin Cutter, 6L (6mm H x 17mm W x 14mm D)
------------	--

CIC-617L-06	Fin Cutter, 6LL (6mm H x 17mm W x 16mm D)
-------------	---

CIC-715-06	Fin Cutter, 7M (7mm H x 15mm W x 12.5mm D)
------------	--

CIC-715L-06	Fin Cutter, 7ML (7mm H x 15mm W x 15mm D)
-------------	---

CIC-717-06	Fin Cutter, 7L (7mm H x 17mm W x 14mm D)
------------	--

CIC-717L-06	Fin Cutter, 7LL (7mm H x 17mm W x 16mm D)
-------------	---

CSH-100-06	Slide Hammer		13
------------	--------------	--	----



CII-678M-06	Insertor, M		14
-------------	-------------	--	----



CII-678L-06	Insertor, L
-------------	-------------

CII-678ML-06	Insertor, ML
--------------	--------------

CII-678LL-06	Insertor, LL
--------------	--------------



M6-C Artificial Cervical Disc Surgical Instruments

CATALOGUE #	DESCRIPTION	INSTRUMENT	LABEL
CTI-100-06	Offset Tamp		15
CDR-100M-06	Acute Disc Removal Tool, M/ML		16
CDR-100L-06	Acute Disc Removal Tool, L/LL		
CIK-200-06	The M6-C™ Artificial Cervical Disc Instrument Kit		

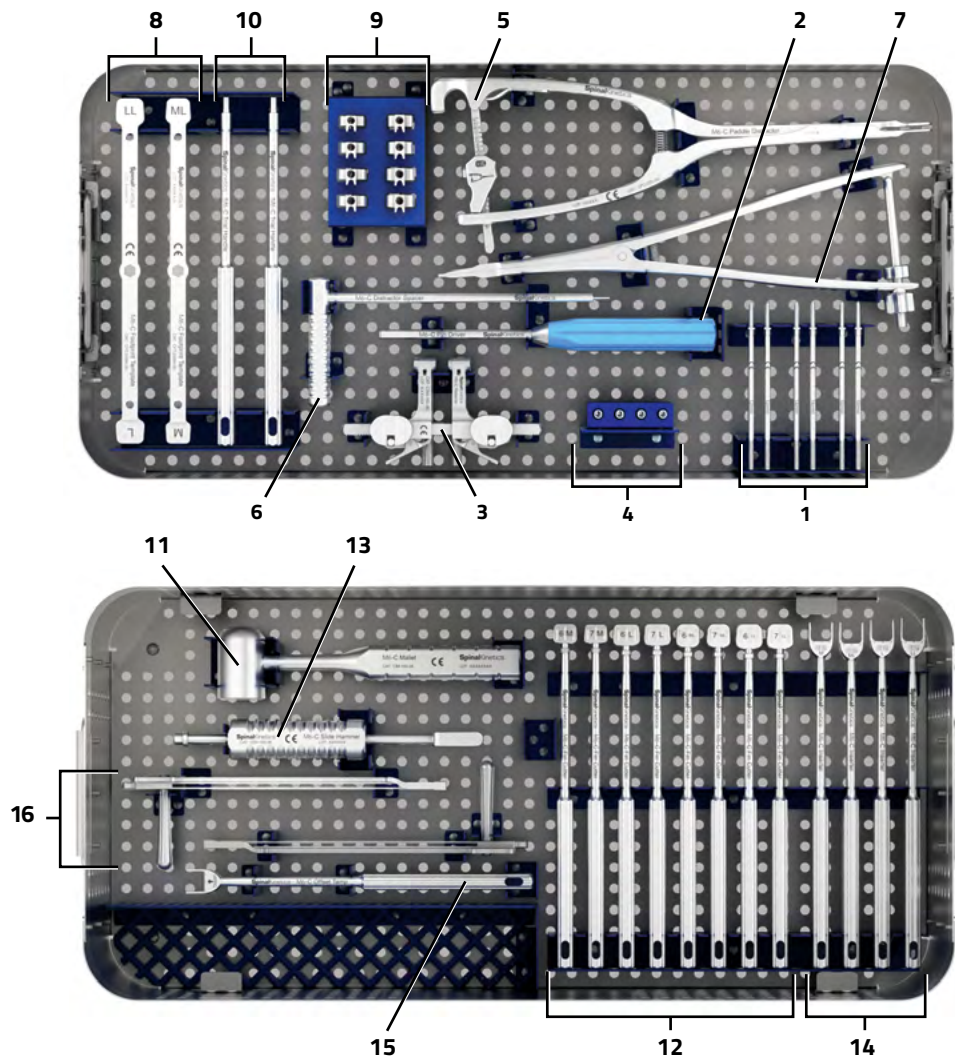

Use Guide for the M6-C Artificial Cervical Disc

INDICATIONS FOR USE

The M6-C™ Artificial Cervical Disc is indicated for reconstruction of the disc following single level discectomy in skeletally mature patients with intractable degenerative cervical radiculopathy with or without spinal cord compression at one level from C3 – C7. Degenerative cervical radiculopathy is defined as arm pain and/or a neurological deficit (numbness, weakness, deep tendon reflexes changes) with or without neck pain due to disc herniation and/or osteophyte formation and confirmed by radiographic imaging (CT, MRI, x-rays). The M6-C™ Artificial Cervical Disc is implanted via an anterior approach. Patients should have failed at least 6 weeks of conservative treatment or exhibit progressive neurological symptoms which could lead to permanent impairment prior to implantation of the M6-C™ Artificial Cervical Disc.

Contraindications

The M6-C™ Artificial Cervical Disc should not be implanted in patients with the following conditions:

- Advanced cervical anatomical deformity (e.g., ankylosing spondylitis, scoliosis) at the operative or adjacent levels
- Symptomatic facet arthrosis defined as pain in the neck that is worse when in extension and/or rotation and/or stiffness or the inability to move part of the neck attributable to the facets as confirmed by imaging (x-ray, CT, MRI, bone scan)
- Advanced degenerative changes (e.g., spondylosis) at the index vertebral level as evidenced by bridging osteophytes, excessive translation or kyphotic deformity $> 11^\circ$ on neutral x-rays
- Active systemic infection or infection at the operative site
- Osteoporosis defined as DEXA bone mineral density T-score ≤ -2.5
- Known allergy to titanium stainless steel, polyurethane, polyethylene, or ethylene oxide residuals

Warnings

Correct placement of the M6-C™ Artificial Cervical Disc is essential to optimal performance.

- The M6-C™ Artificial Cervical Disc should only be used by surgeons who are experienced in the surgical procedure and have undergone adequate training with this device. A lack of adequate experience and/or training may lead to a higher incidence of adverse events, such as vascular or neurological complications.
- During implantation, the surgeon should ensure that none of the surgical instruments or the M6-C™ Artificial Cervical Disc progress beyond the posterior border of the vertebral bodies. Due to the proximity of vascular and neurological structures to the implantation site, there are risks of serious or fatal hemorrhage and risks of neurological damage with the use of this device, and allowing the instruments or the M6-C™ Artificial Cervical Disc to progress beyond the posterior border of the vertebrae may result in injury to these structures.
- Fluoroscopic confirmation of positioning of certain instruments and the implant should be performed during the surgical procedure. Failure to confirm position of instruments and the implant during the surgical implantation procedure may result in patient injury.

Precautions

The safety and effectiveness of the M6-C™ Artificial Cervical Disc has not been established in patients with the following conditions:

- Those over 68 years of age
- More than one cervical level requiring surgery
- Previous anterior cervical spine surgery at the index level
- Axial neck pain as the solitary symptom
- Previous posterior cervical spine surgery (e.g., posterior element decompression) that destabilizes the cervical spine at the index level
- Less than 4° of motion in flexion/extension at the index level
- Instability as evidenced by subluxation > 3 mm at the index or adjacent levels as indicated on flexion/extension x-rays
- History of an osteoporotic fracture of the spine, hip or wrist
- History of an endocrine or metabolic disorder (e.g., Paget's disease) known to affect bone and mineral metabolism
- Taking medications that may interfere with bony/soft tissue healing including chronic steroid use
- Insulin-dependent diabetes
- Severe obesity (Body Mass Index > 40)

Use Guide for the M6-C Artificial Cervical Disc (cont.)

Pre-Operative:

- Patient selection is extremely important. In selecting patients for a total disc replacement, the following factors can be of extreme importance to the success of the procedure: the patient's occupation or activity level; a condition of senility, mental illness, alcoholism or drug abuse; certain degenerative diseases that may be so advanced at the time of implantation that the expected useful life of the device is substantially decreased, and medical conditions that may affect postoperative management, such as Alzheimer's disease and emphysema.
- In order to minimize the risk of periprosthetic vertebral fractures, surgeons must consider all co-morbidities, past and present medications, previous treatments, etc. A screening questionnaire for osteopenia or osteoporosis, SCORE (Simple Calculated Osteoporosis Risk Estimation), may be used to screen patients to determine if a DEXA scan to measure bone mineral density is necessary. If a DEXA scan is performed, the patient should be excluded from receiving the device if osteoporosis is present as defined by a T score ≤ -2.5 .
- The patient should be informed of the potential adverse effects (risks/complications) contained in this insert (see Safety Results / Adverse Events).
- Information on the proper implant site preparation, implant size selection, and the use of surgical instrumentation for the M6-C™ Artificial Cervical Disc is provided in the *M6-C™ Artificial Cervical Disc Operative Technique Manual* and the *Care and Handling Instructions for M6-C™ Surgical Instruments* and should be reviewed prior to surgery.
- Preoperative planning may be used to estimate the required implant size and to assure that the appropriate range of sizes is available for surgery. Correct selection of the appropriate implant size is extremely important to assure the placement and function of the disc. The procedure should not take place if the appropriate range of sizes are not available.
- The M6-C™ Artificial Cervical Disc is intended to be used with the M6-C™ Surgical Instruments. The M6-C™ Surgical Instruments are reusable, supplied non-sterile and must be sterilized in accordance with the recommended cleaning and sterilization procedures prior to use.
- The M6-C™ Artificial Cervical Disc is supplied sterile. It is not intended to be re-sterilized. Do not use if sterility is compromised.
- Examine all instruments prior to surgery for wear or damage. Instruments which have been used excessively may be more likely to break. Replace any worn or damaged instruments.

Intra-Operative:

- Use aseptic technique when removing the M6-C™ Artificial Cervical Disc from the innermost packaging. Carefully inspect each device and its packaging for any signs of damage, including damage to the sterile barrier. Do not use the M6-C™ Artificial Cervical Disc if the packaging is damaged or the implant shows signs of damage.
- Use care when handling the M6-C™ Artificial Cervical Disc to ensure that it does not come into contact with objects that could damage the implant. Damaged implants are no longer functionally reliable. Visual inspection of the prosthesis is recommended prior to implanting the device. If any part of the device appears damaged or not fully assembled, do not use.
- The M6-C™ Artificial Cervical Disc should not be used with instruments of spinal systems from other manufacturers. See the Operative Technique Manual for step-by-step instructions.
- Take care not to over-distract the disc space.
- Perform a complete discectomy of the disc space between the uncinates and up to the posterior ligament. Take care to release / decompress the foramen bilaterally.
- Excessive removal of endplate cortical bone may result in sub-optimal outcomes.
- It is important to remove all anterior and posterior osteophytes on the superior and inferior vertebral endplates. Liberally cover bleeding with bone wax. To prevent weakening of the endplates, use of a burr/drill is discouraged during endplate preparation. Use the Cervical Retainer as needed to maintain distraction. Ensure proper alignment and placement of the device as misalignment may cause excessive wear and/or early failure of the device.
- The M6-C™ Artificial Cervical Disc is designed to be implanted with the endplates parallel to each other. Excessive endplate lordosis or kyphosis can lead to less than optimal M6-C™ Artificial Cervical Disc performance.
- Surgical implants must never be re-used or re-implanted. Even though the device appears undamaged, it may have small defects and internal stress patterns that can lead to early breakage.

Post-Operative:

- Patients should be instructed in postoperative care procedures and should be advised of the importance of adhering to these procedures for successful treatment with the device including the avoidance of heavy lifting, repetitive bending, and prolonged or strenuous activity initially and for a period of weeks to months depending on the individual patient's progress and the stability and functioning of the implant.

Note to Physician: Although the physician is the learned intermediary between the company and the patient, the important medical information given in this document should be conveyed to the patient.

Use Guide for the M6-C Artificial Cervical Disc (cont.)

MRI Safety Information

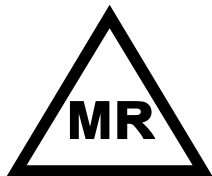

Non-clinical testing has demonstrated that the M6-C™ Artificial Cervical Disc is MR Conditional. A patient with the M6-C™ Artificial Cervical Disc can be scanned safely in an MR system under the following conditions:

- Static magnetic field of 1.5-T or 3.0-T, only
- Maximum spatial gradient magnetic field of 4,000-Gauss/cm (40-T/m)
- Maximum MR system reported whole body averaged specific absorption rate (SAR) of 2-W/kg for 15 minutes of scanning (i.e., per pulse sequence) in the Normal Operating Mode.

Under the scan conditions defined, the M6-C™ Artificial Cervical Disc is expected to produce a maximum temperature rise of 2.2°C after 15-minutes of continuous scanning (i.e., per pulse sequence).

In non-clinical testing, the image artifact caused by the M6-C™ Artificial Cervical Disc extends approximately 10-mm from this device when imaged using a gradient echo pulse sequence and a 3.0-Tesla MR system.

Product Complaints

Any health care professional (e.g., customer or user of this system), who has complaints or who has experienced any dissatisfaction in the product quality, identity, durability, reliability, safety, effectiveness and/or performance, should notify Orthofix. Further, if the device (implant or instruments) ever “malfunctions,” (i.e. does not meet any of its performance specifications or otherwise does not perform as intended), or may have caused or contributed to the death or serious injury of a patient, Orthofix should be notified immediately by telephone or written correspondence. When filing a complaint, please provide the device name and serial number, lot number, your name and address, and the nature of the complaint. Complaints may also be reported directly to Medwatch at <http://www.fda.gov/medwatch>. In the event that the M6-C™ Artificial Cervical Disc requires removal for any reason, follow the instructions provided below in the DEVICE RETRIEVAL section.

Device Retrieval

Please contact Orthofix to receive specific instructions regarding the preferred method for explant handling and transport as well as data collection, including histopathological, mechanical, patient, and adverse event information. Please refer to the M6-C™ Artificial Cervical Disc Operative Technique Manual for step-by-step instructions on the required operative technique for device removal. All explanted devices must be returned to Orthofix for analysis.

It is preferred that no cleaning, decontamination or sterilization be performed at the hospital. Some surgical centers may require that the device be decontaminated or sterilized prior to leaving the facility. Note that many sterilization methods will damage the device (e.g., autoclaving, immersion in alcohol), and the effects of other methods are unknown. Rinsing with water or saline is acceptable. If decontamination and sterilization are required, 10% neutral buffered formalin is best. If cleaning, decontamination, or sterilization is performed, note what cleaning methods and materials were used.

It is preferred that the explanted device is packed “dry” (no fluid) or wrapped in formalin-soaked gauze. The device can be gently rinsed with water or saline to remove excess blood and fluids.

Send the explanted device in a leak-proof container, with the date of removal, explanting surgeon, and any known information regarding initial implantation, reasons for removal, and adverse event information. Please note that the explanted M6-C™ Artificial Cervical Disc should be removed as carefully as possible in order to keep the implant and surrounding tissue intact if possible. Also, please provide descriptive information about the gross appearance of the device in situ, as well as descriptions of the removal methods, i.e., intact or in pieces. Orthofix will request additional information regarding the reason for removal, patient information and associated clinical outcomes.

NOTE: All implant removals must be reported immediately to Orthofix.

CONTACT INFORMATION

Orthofix

3451 Plano Parkway
Lewisville, Texas 75056 USA
Customer Service: 888-298-5700
OSI-CustomerService@orthofix.com
M6info@orthofix.com
www.orthofix.com

Manufactured by:

Spinal Kinetics LLC, an Orthofix Company
501 Mercury Drive
Sunnyvale, California 94085 USA
888-298-5700

A complete Summary of Safety and Effectiveness (SSED), and labeling information for the M6-C™ Artificial Cervical Disc may be obtained at www.fda.gov by searching PMA number P170036.

Please visit Orthofix.com/IFU for full information on indications for use, contraindications, warnings, precautions, adverse reactions information and sterilization.

Caution: Federal law (USA) restricts this device to sale by or on the order of a physician. Proper surgical procedure is the responsibility of the medical professional. Operative techniques are furnished as an informative guideline. Each surgeon must evaluate the appropriateness of a technique based on his or her personal medical credentials and experience.

Orthofix
3451 Plano Parkway
Lewisville, Texas 75056 USA
Customer Service: 888-298-5700
OSI-CustomerService@orthofix.com
M6info@orthofix.com



Manufactured by:
Spinal Kinetics LLC, an Orthofix Company
501 Mercury Drive
Sunnyvale, California 94085 USA

Orthofix products or services referenced herein are trademarks or registered trademarks of Orthofix Medical Inc. and its group of companies. Any rights not expressly granted herein are reserved.