

## Operative Technique

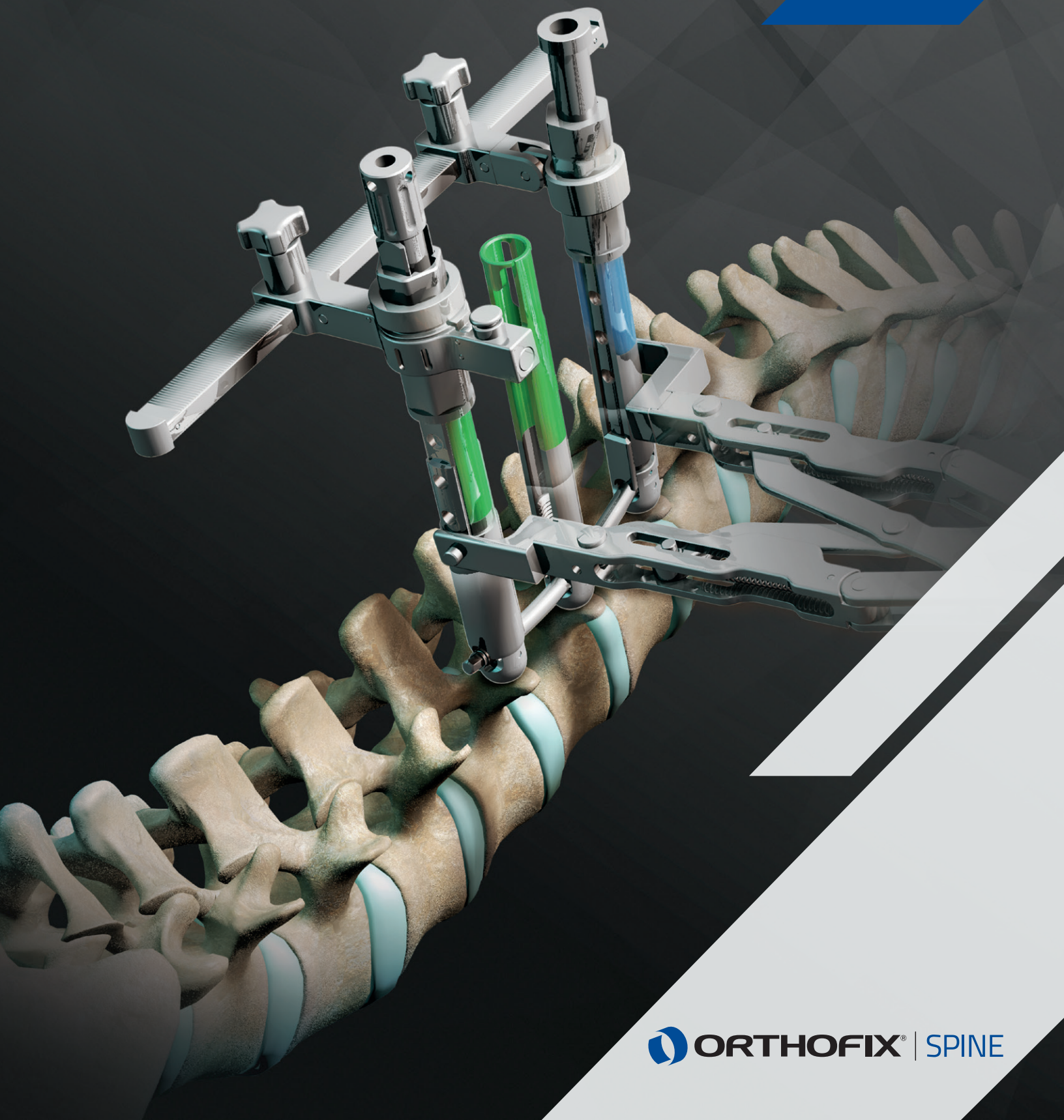

## Table of Contents

1	Introduction
2	Operative Technique
14	Instruments
16	Order by Request
17	Part Numbers

The surgical technique shown is for illustrative purposes only. The technique(s) actually employed in each case will always depend upon the medical judgment of the surgeon exercised before and during surgery as to the best mode of treatment for each patient. Please see the Instructions For Use for the complete list of indications, warnings, precautions, and other important medical information.

## INTRODUCTION

As an extension to the already versatile Phoenix Minimally Invasive System, Phoenix Compression Distraction Extension offers even greater implant and instrument options for complex MIS deformity spinal fixation.

### System Overview:

- Compression/Distraction
  - Long throw Compressor and Distractor
  - Interchangeable tips
- Direct Vertebral Rotation
  - DVR Towers and Connectors
- Additional Features
  - Extra Large Ratcheting Connector
  - MIS Counter Torque Tower
  - Improved Rod Inserter
  - Fast Drive
  - 450mm CoCr rods

### Please refer to the Phoenix Operative Technique for:

Pre-Operative Planning

- Patient Positioning
- Pedicle Identification and Incision Planning

Operative Technique

- Incision and Guide Wire Insertion
- Pedicle Preparation and Tissue Dilation
- Multi-Axial Screw Placement

### Please refer to this Operative Technique for:

- Screw Placement
- Rod Insertion
- Compression/Distraction
- DVR

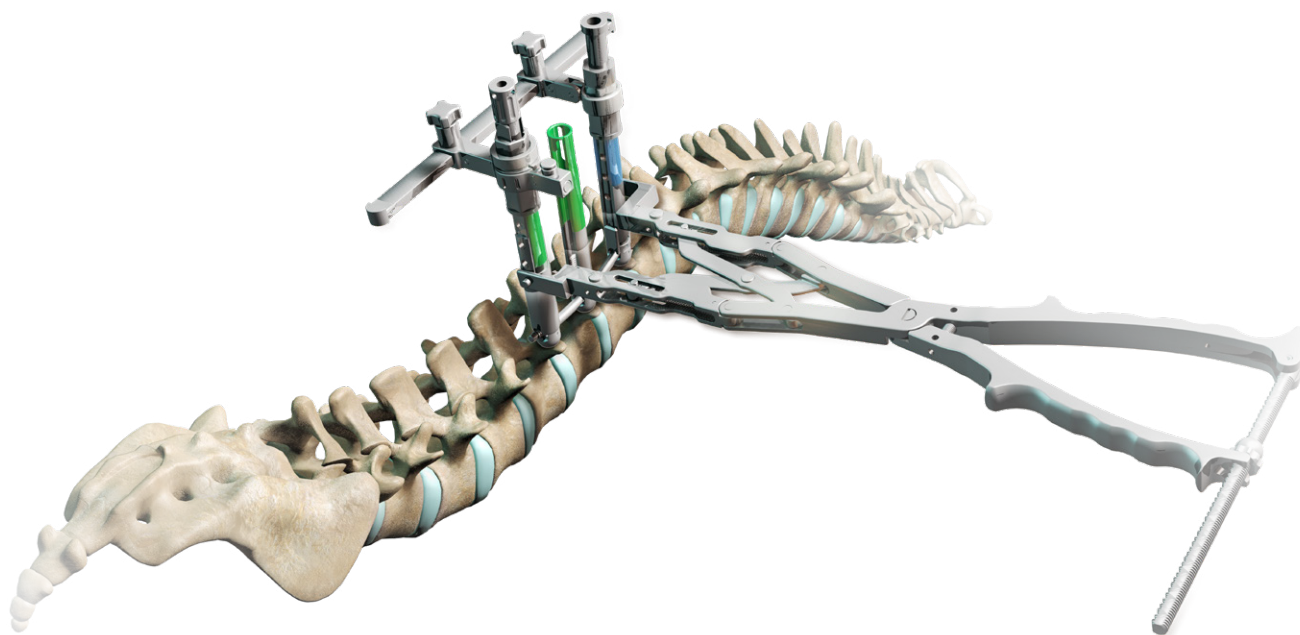

## 1. MONO-AXIAL SCREW PLACEMENT

### Mono-Axial Open Body, Standard

The **Mono-Axial Open Body, Standard (20-8090)** is used to keep the bone screw co-axial to the screw body. The Mono-Axial Open Body, Standard can be used anywhere a surgeon would prefer a mono-axial screw for additional rigidity during spinal correction. Mono-Axials are especially useful during DVR procedures.

Phoenix Mono-Axial Open Bodies, Standard are indicated by a blue color. (**Fig. 1A**) It is ideal to have approximately 50% of the reduction head visible above the surface of the skin.

### Mono-Axial Screw Driver

Attach the appropriate Mono-Axial Open Body, Standard onto the desired cannulated Firebird Modular Screw. The square boss head of the Mono-Axial Open Body, Standard must be securely seated in the bone screw. Confirm a secure connection by pulling on the screw.

Insert the **Mono-Axial Screw Driver (20-0300)** with either the **Straight Ratcheting Handle (52-1013)** or the **Ratcheting T-Handle (52-1011)** into the Mono-Axial Open Body. Rotate the knob on the Mono-Axial Screw Driver in a clockwise direction to assemble the Mono-Axial Open Body, Standard onto the Mono-Axial Screw Driver tip. Confirm the screw is attached to the Mono-Axial Screw Driver and do not over-tighten. (**Fig. 1B**)



Fig. 1A



Fig. 1B

Using the Mono-Axial Screw Driver, guide the screw of appropriate length over the guide wire into the prepared pedicle. Remove the guide wire after the screw enters the vertebral body. Periodically check fluoroscopy to ensure proper screw placement based on surgeon preference. **(Fig. 1C)**

Once the screw is seated to the appropriate level, turn the knob of the Mono-Axial Screw Driver in a counter-clockwise direction and remove. **(Fig. 1D)**

Place the remaining screws by repeating the same technique.

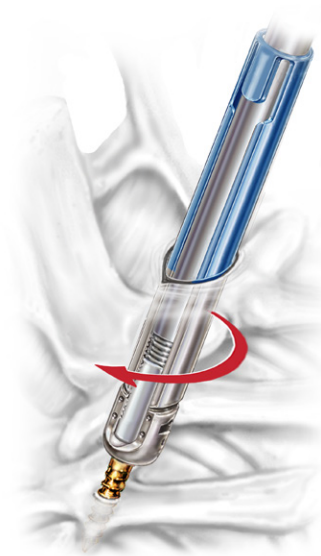

Fig. 1C

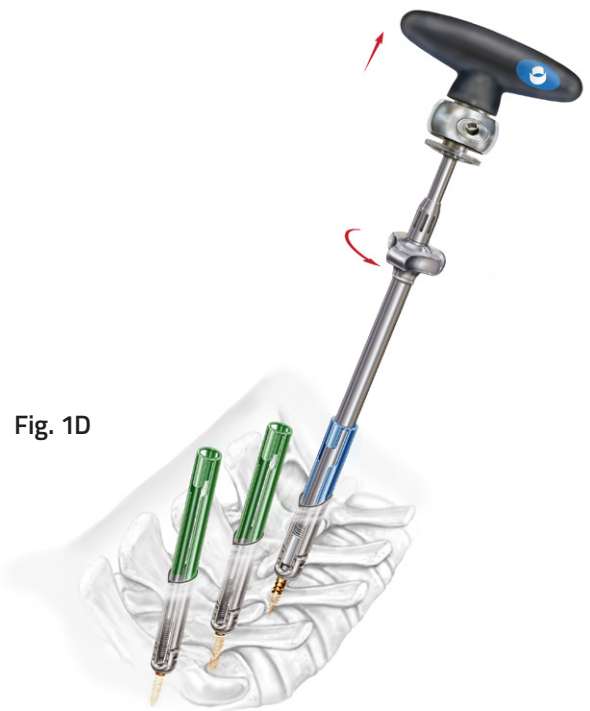

Fig. 1D

## 2. ROD INSERTION

Align the hex end of the implant with the hex mating features on the **Rod Inserter (20-0313)** at the desired orientation. The groove of the rod should be aligned with the tooth on the shaft of the Rod Inserter. This will prevent the rod from disengaging during insertion. **(Fig. 2A)**

Rotate the knob on the Rod Inserter in a clockwise motion to securely engage the rod. To extend the life of the Rod Inserter, do not over-tighten; excessive torque is not required to achieve a rigid connection. **(Fig. 2B)**

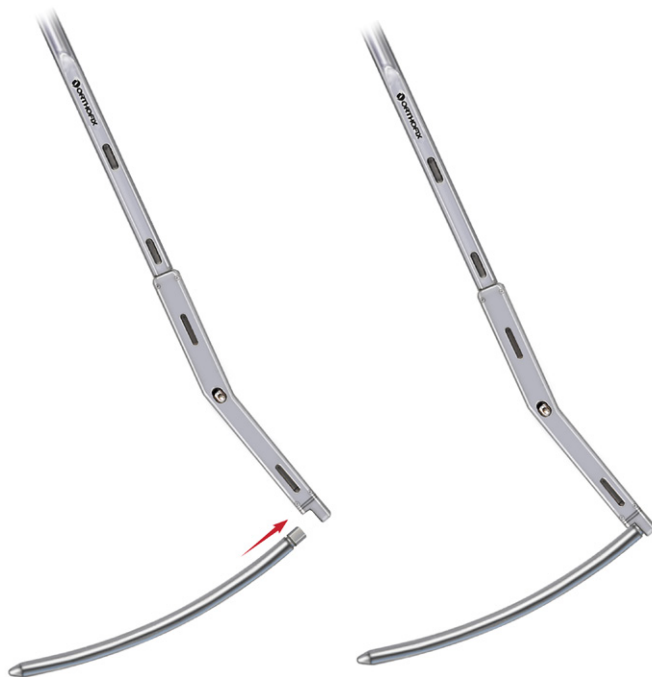

Fig. 2A



Fig. 2B

When the tip of the rod enters the Phoenix Mono-Axial or Multi-Axial Bodies, begin to rotate the Rod Inserter handle which will push the rod through to the adjacent levels. **(Fig. 2C)**

Once the rod is seated, the Rod Inserter handle will be approximately perpendicular to the patient. **(Fig. 2D)**

After set screws have been provisionally tightened, turn the knob on the Rod Inserter in a counter-clockwise direction to release the rod.

**NOTE:** For longer constructs (over 150mm), the required rod length can be measured by laying either a k-wire or rod at skin level. It is recommended to start with some additional length, as sequential trialing and cutting of the rod may be required to optimize the final rod length.



Fig. 2C



Fig. 2D

### 3. FAST DRIVE (OPTIONAL)

The **Fast Drive (20-0310)** can be used to quickly thread **Set Screws (44-2001)** through the reduction area of the Phoenix Mono-Axial and Multi-Axial Bodies. To connect the Fast Drive to the **Set Screw Driver (20-0340)**, compress the tip of the proximal end of the Fast Drive to engage the 1/4" quick connect of the Set Screw Driver. **(Fig. 3A)**

Place either a Straight Ratcheting Handle or the Ratcheting T-Handle on the distal end of the Fast Drive. **(Fig. 3B)**

When placing Set Screws, hold the body of Fast Drive with one hand while turning the Ratcheting T-Handle or Straight Ratcheting Handle.

**NOTE:** Do not use Fast Drive for final tightening.

**NOTE:** Fast Drive rotates Set Screw Driver approximately three times per turn.

**NOTE:** Also available for set screw insertion is the **Handle Adapter, (20-0311)**. The handle adapter interfaces between a **T-Handle** and the **Set Screw Holder (20-0250, 20-0251)** for better grip while inserting set screws

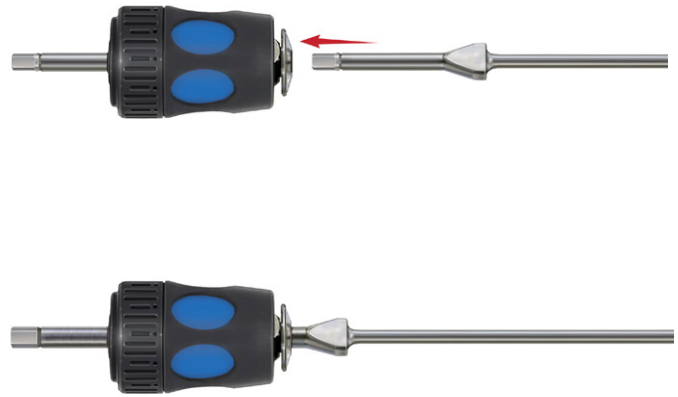

Fig. 3A



Fig. 3B



#### 4. MIS COUNTER TORQUE

Prior to using the **MIS Counter Torque Tower (20-0321)**, one small tab must be removed. (See Section 10, Tab Removal of the Phoenix Spinal Fixation Operative Technique)

The MIS Counter Torque Tower is inserted in the cannula of the Phoenix Body at an initial 45 degree angle.

**(Fig. 4A)**

Once the fork of the MIS Counter Torque Tower is properly placed in the middle of the tall tabs on the Phoenix Body, the instrument can be straightened and advanced, until seated flush against the rod. The hex ring of the MIS Counter Torque Tower should be placed over the top of the large tabs, protecting them from prematurely breaking. **(Fig. 4B)**

**NOTE:** The rail on the side of the MIS Counter Torque Tower should be placed on the side of the Phoenix Body where the small tab was removed.

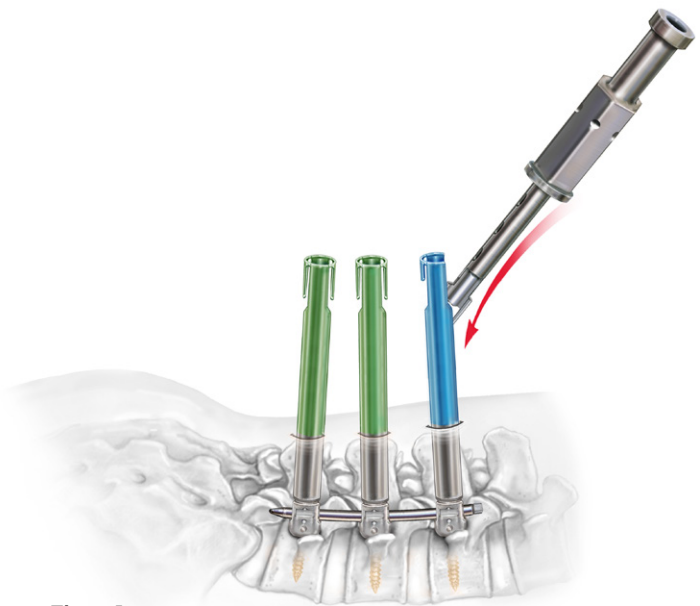

**Fig. 4A**

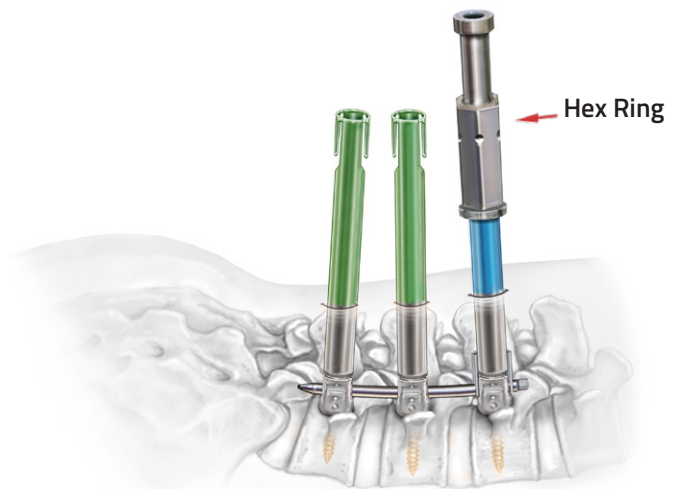

**Fig. 4B**

## 5. DVR TOWER

To attach the **DVR Tower, Short - Standard (20-0330)**, remove both small tabs on the Phoenix Body. (See Section 10, Tab Removal Phoenix Spinal Fixation System Operative Technique) Once both small tabs have been removed, the DVR Tower, Short - Standard can be placed over the top of the Phoenix Screw Body. The DVR Tower, Short - Standard rigidly attaches to the Phoenix Mono-Axial or Multi-Axial Bodies through a threaded shaft that engages the top few reduction threads of the Phoenix Mono-Axial or Multi-Axial Body. If the DVR Tower, Short - Standard cannot be seated enough to engage the threads, additional reduction of the Set Screw may be required. **(Fig. 5A)**

**NOTE:** DVR Towers, Short - Standard can be used for both Compression/Distraction as well as facilitation of a DVR procedure.

**NOTE:** The DVR Tower can only be used with short and standard Phoenix Bodies.

To reduce further, insert the Set Screw Driver through the center cannula on the DVR Tower, Short - Standard and engage the Set Screw. Once adequate reduction has been obtained, the top of the DVR Tower, Short - Standard can be twisted until the threaded shaft within the DVR Tower, Short - Standard is engaged in the Phoenix Body.

The hex ring of the DVR Tower, Short - Standard should be placed over the top of the large tabs, protecting them from prematurely breaking. **(Fig. 5B)**

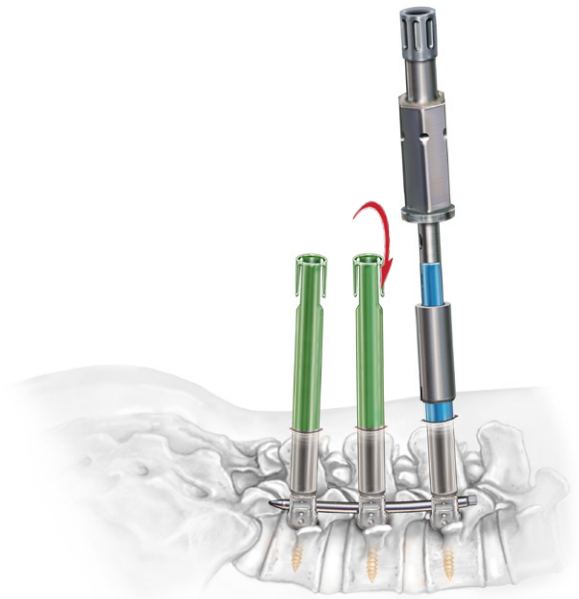

Fig. 5A

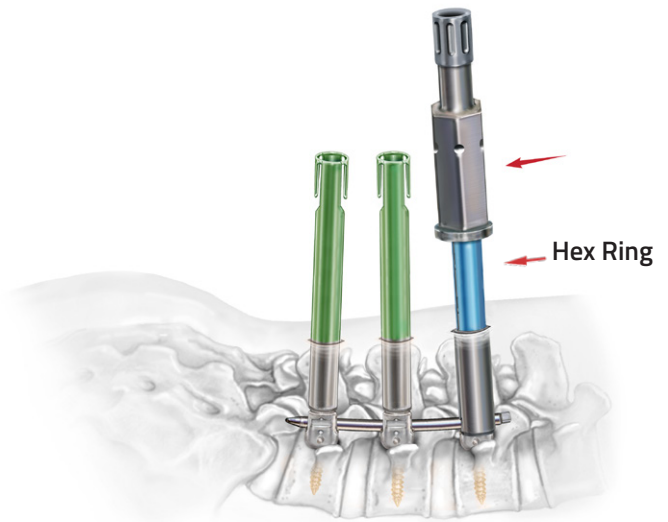

Fig. 5B

## 6. DIRECT VERTEBRAL ROTATION (DVR)

(\*See section 5 for DVR Tower, Short - Standard attachment)

DVR Tower, Short - Standard must be bilaterally attached to the Phoenix Mono-Axial or Multi-Axial Body on each side of a vertebral level in order to perform DVR. Once both DVR Towers, Short - Standard have been attached, **Extra Large Ratcheting Connectors (51-1986)** can be added to link the two DVR Towers, Short - Standard. **(Fig. 6A)**

Attach the Extra Large Ratcheting Connectors to the proximal ends of the DVR Tower, Short - Standard by sliding the spherical interface over the cylindrical retention sleeve at the top of each DVR Tower, Short - Standard. **(Fig. 6B)**



Fig. 6A

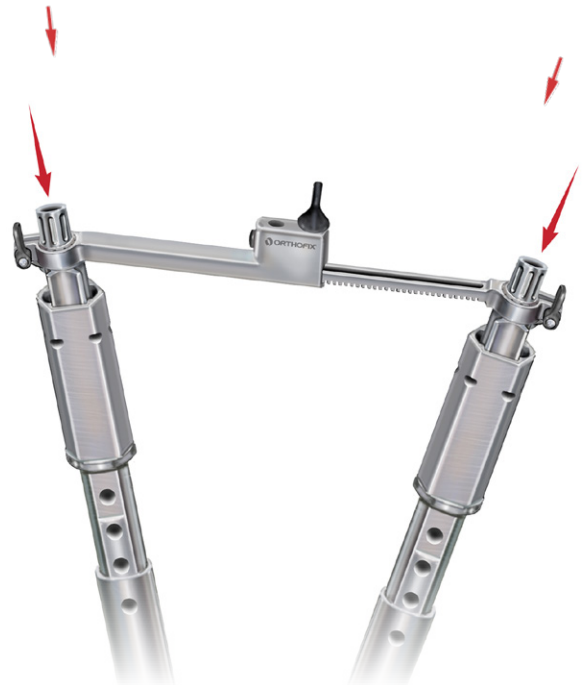

Fig. 6B

To adjust the medial/lateral size of the Extra Large Ratcheting Connector, slide the rack to the desired length and turn the top knob 90° to the locked position. **(Fig. 6C)**

To adjust the trajectory of the DVR Tower, Short - Standard turn the lever at each of the Extra Large Ratcheting Connector 1/4 turn until the spherical interfaces tighten around the retention sleeve. **(Fig. 6D)**

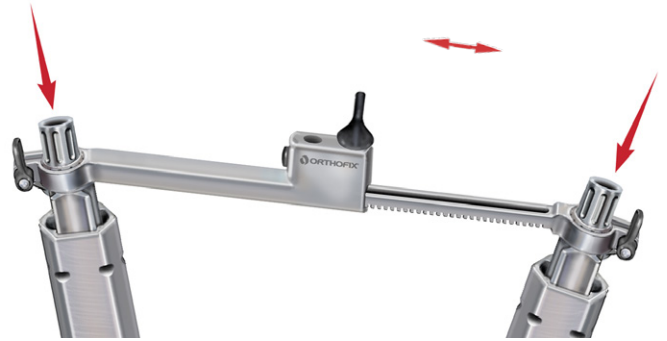

Fig. 6C



Fig. 6D

Attach the **Rotation Handle (51-1486)** to the handle connector hole on top of the Extra Large Ratcheting Connector. **(Fig. 6E)**

Repeat the above steps for each level to be rotated. Perform the DVR maneuver as appropriate to achieve the rotational correction desired. **(Fig. 6F)**

Note: If final tightening is desired after rotation, it may be achieved by using Set Screw Driver along with the **Torque Limiting Handle (55-1068)**.

**NOTE:** A Counter Torque Wrench is not required as linked DVR Towers, Short - Standard provide sufficient counter torque for final tightening.

**NOTE:** Transferring the desired rotation to the vertebral body may be more easily achieved with the use of the Phoenix Mono-Axial body, which is indicated by the blue color.



Fig. 6E



Fig. 6F

## 7. COMPRESSION/DISTRACTION

To accommodate surgeon preferences, a variety of interchangeable options are available for Compression and/or Distraction. Each option uses a combination of three components.

### Compression/Distraction Table

Section A	Section B	Section C
<b>Tower instruments to protect implants.</b>	<b>Fulcrum instrument to protect implants.</b>	<b>Compressor or Distractor Instrument</b>
MIS Counter Torque Tower 20-0321	Compression/Distraction Fixture 20-0320	Compressor 20-0380 (provide variable width compression)
DVR Tower, Short - Standard 20-0330		Distractor 20-0381 (provide variable width distraction)

**NOTE: Compressor (20-0380) and Distractor (20-0381)** are used with the **C/D Tips (20-0382, 20-0383, and 20-0384)** to achieve a compression or distraction instrument to span the desired distance between the desired vertebral levels. Push the button on the tip of the Compressor or Distractor while simultaneously inserting the C/D Tips. All of the C/D tips can be inserted in the Compressor or Distractor in two orientations.

### Compression/Distraction

Apply the desired Tower instrument (see options in Section A of Compression/Distraction Table) over each Phoenix Mono-Axial or Multi-Axial Body to which you are going to apply compression forces. Application of compression forces directly to the Phoenix Mono-Axial or Multi-Axial Body without use of a Tower is not recommended.

Next, place the **Compression/Distraction Fixture (20-0320)** (see options in Section B of Compression/Distraction Table) over the top of the towers. To adjust the fixture to the desired width and orientation, loosen the thumb screws of each slider to allow the sliders to translate along the length of the instrument. One slider can move up, down, and around and the other slider can rotate by compressing the black button on the top of the slider. Once the sliders have been placed over the tops of the hex features of the MIS Counter Torque Tower or DVR Tower, Short - Standard lock the adjustment knobs on the fixture.

Attach the desired compression/distraction instrument (see options in Section C of Compression/Distraction Table) to the holes in the tower closest to the level of the skin. Compress/Distract the towers to the desired position and proceed to final tightening of Set Screws. **(Fig. 7A, 7B)**

**NOTE:** Provisionally tighten one of the set screws while compressing.

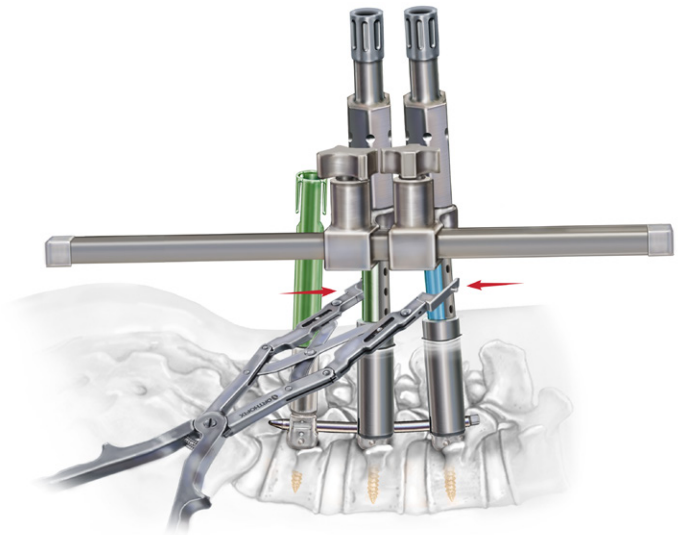

Fig. 7A

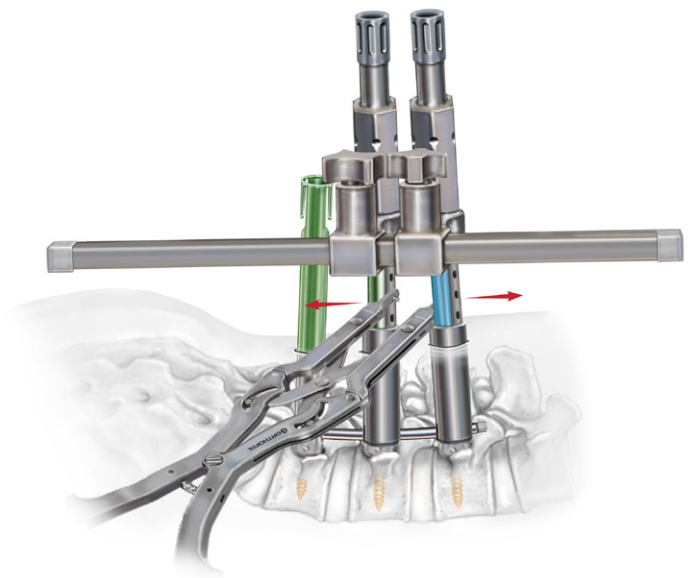

Fig. 7B

## 8. FINAL TIGHTENING

To accommodate surgeon preferences, a variety of interchangeable options are available for final tightening of the construct. The options use a combination of three components.

- a. Tower instrument to protect the implant
  - i. MIS Counter Torque Tower
  - ii. DVR Tower, Short - Standard
- b. **Counter Torque Wrench (20-0225)**
- c. Set Screw Driver attached to Torque Limiting Handle

### OPTION 1

The Counter Torque Wrench slides over the hex end of the MIS Counter Torque Tower. The Torque Limiting Handle is attached to the Set Screw Driver and is passed down the MIS Counter Torque Tower to mate with the Set Screw. Turn the Torque Limiting Handle clockwise to tighten the Set Screw to 100 in/lbs. The handle will reach its maximum torque and release at 100 in/lbs. as indicated by a tactile and audible snap.

**NOTE:** Prior to using the MIS Counter Torque Tower one small tab must be removed. (See Section 10, Tab Removal Phoenix Spinal Fixation System Operative Technique)

### OPTION 2

The Counter Torque Wrench slides over the hex end of the DVR Tower, Short- Standard. The Torque Limiting Handle is attached to the Set Screw Driver and is passed down the DVR Tower, Short- Standard to mate with the Set Screw. Turn the Torque Limiting Handle clockwise to tighten the Set Screw to 100 in/lbs. The handle will reach its maximum torque and release at 100 in/lbs. as indicated by a tactile and audible snap. (**Fig. 8A, 8B**)

**NOTE:** Prior to using the DVR Tower, Short - Standard both small tabs must be removed. (See Section 10, Tab Removal Phoenix Spinal Fixation System Operative Technique)









Fig. 8A



Fig. 8B

## Instruments

	Part #	Description
	20-0320	Compression/Distraction Fixture
	20-0380	Compressor
	20-0381	Distractor
	20-0382	Compression/Distraction Tip
	20-0383	Offset Compression/Distraction Tip, 30mm
	20-0384	Offset Compression/Distraction Tip, 60mm



## Order by Request

	Part #	Description
	20-8090	Mono-Axial Open Body, Standard
	20-0310	Fast Drive
	20-0311	Handle Adapter
	20-0313	Rod Inserter
	20-0321	MIS Counter Torque Tower
	20-0330	DVR Tower, Short - Standard
	51-1986	Extra Large Ratcheting Connector

Order by Request

**Part #**      **Description**

**20-0300**      Mono-Axial Screw Driver



**20-0340**      Set Screw Driver



## Part Numbers

Part #	Description
<b>Top Level</b>	
20-0320	Compression/Distractor Fixturew
20-0380	Compressor
20-0381	Distractor
20-0382	Compression/Distractor Tip
20-0383	30mm Offset Compression/Distractor Tip
20-0384	60mm Offset Compression/Distractor Tip
20-7450	450mm Rod, CoCr
<b>Implants, Order By Request</b>	
20-8090	Mono-Axial Open Body, Standard
20-4200	200mm Prelordosed Rod
<b>Instruments, Order By Request</b>	
20-0300	Mono-Axial Screw Driver
20-0310	Fast Drive
20-0311	Handle Adapter
20-0313	Rod Inserter
20-0321	MIS Counter Torque Tower
20-0330	DVR Tower, Short - Standard
20-0340	Set Screw Driver
51-1986	Extra Large Ratcheting Connector
51-1486	Rotation Handle

Please visit [Orthofix.com/IFU](https://Orthofix.com/IFU) for full information on indications for use, contraindications, warnings, precautions, adverse reactions and sterilization.

Caution: Federal law (USA) restricts this device to sale by or on the order of a physician. Proper surgical procedure is the responsibility of the medical professional. Operative techniques are furnished as an informative guideline. Each surgeon must evaluate the appropriateness of a technique based on his or her personal medical credentials and experience.

 Orthofix  
3451 Plano Parkway  
Lewisville, Texas 75056-9453 USA  
1.214.937.3199  
1.888.298.5700  
[www.orthofix.com](http://www.orthofix.com)



Medical Device Safety Services (MDSS):  
Schiffgraben 41  
30175, Hannover  
Germany  
+49 511 6262 8630  
[www.mdss.com](http://www.mdss.com)

Australian Sponsor  
Emergo Australia  
Level 20, Tower II  
Darling Park  
201 Sussex Street  
Sydney, NSW 2000  
Australia

**Rx Only**  

Orthofix products or services referenced herein are trademarks or registered trademarks of Orthofix Medical Inc. and its group of companies. Any rights not expressly granted herein are reserved.